

Instruction manual

(22311: 891)

(26795: 892)

(24288: 893PK)

(25417: 894PK)

(27168: 895PK)



MODEL 8931

To learn more about Porter-Cable
visit our website at:

<http://www.porter-cable.com>

PORTER-CABLE
PROFESSIONAL POWER TOOLS

ESPAÑOL: PÁGINA 21
FRANÇAISE : PAGE 39

Routers



MODEL 891



MODEL 892

IMPORTANT

Please make certain that the person who is to use this equipment carefully reads and understands these instructions before starting operations.

The Model and Serial No. plate is located on the main housing of the tool. Record these numbers in the spaces below and retain for future reference.

Model No. _____

Type _____

Serial No. _____

TABLE OF CONTENTS

IMPORTANT SAFETY INSTRUCTIONS	2
SAFETY GUIDELINES	3
GENERAL SAFETY RULES	4
ADDITIONAL SPECIFIC SAFETY RULES	6
CARTON CONTENTS	8
FUNCTIONAL DESCRIPTION	9
ASSEMBLY	9
OPERATION	14
TROUBLESHOOTING	18
MAINTENANCE	18
SERVICE	19
ACCESSORIES	19
WARRANTY	20
ESPAÑOL	21
FRANÇAISE	39

IMPORTANT SAFETY INSTRUCTIONS

▲ WARNING Read and understand all warnings and operating instructions before using any tool or equipment. When using tools or equipment, basic safety precautions should always be followed to reduce the risk of personal injury. Improper operation, maintenance or modification of tools or equipment could result in serious injury and property damage. There are certain applications for which tools and equipment are designed. Porter-Cable strongly recommends that this product NOT be modified and/or used for any application other than for which it was designed.

If you have any questions relative to its application DO NOT use the product until you have written Porter-Cable and we have advised you.

Online contact form at www.porter-cable.com

Postal Mail: Technical Service Manager

Porter-Cable
4825 Highway 45 North
Jackson, TN 38305

Information regarding the safe and proper operation of this tool is available from the following sources:

Power Tool Institute

1300 Sumner Avenue, Cleveland, OH 44115-2851

www.powertoolinstitute.org

National Safety Council

1121 Spring Lake Drive, Itasca, IL 60143-3201

American National Standards Institute, 25 West 43rd Street, 4 floor, New York, NY 10036 www.ansi.org ANSI 01.1 Safety Requirements for Woodworking Machines, and the U.S. Department of Labor regulations www.osha.gov

SAVE THESE INSTRUCTIONS!

SAFETY GUIDELINES - DEFINITIONS

It is important for you to read and understand this manual. The information it contains relates to protecting YOUR SAFETY and PREVENTING PROBLEMS. The symbols below are used to help you recognize this information.



▲ DANGER indicates an imminently hazardous situation which, if not avoided, will result in death or serious injury.

▲ WARNING indicates a potentially hazardous situation which, if not avoided, could result in death or serious injury.

▲ CAUTION indicates a potentially hazardous situation which, if not avoided, may result in minor or moderate injury.

CAUTION used without the safety alert symbol indicates a potentially hazardous situation which, if not avoided, may result in property damage.

CALIFORNIA PROPOSITION 65

▲ WARNING Some dust created by power sanding, sawing, grinding, drilling, and other construction activities contains chemicals known (to the State of California) to cause cancer, birth defects or other reproductive harm. Some examples of these chemicals are:

- lead from lead-based paints
- crystalline silica from bricks and cement and other masonry products
- arsenic and chromium from chemically-treated lumber

Your risk from these exposures varies, depending on how often you do this type of work. To reduce your exposure to these chemicals: work in a well ventilated area, and work with approved safety equipment, always wear NIOSH/OSHA approved, properly fitting face mask or respirator when using such tools.

GENERAL SAFETY RULES

▲ WARNING Read all instructions. Failure to follow all instructions listed below may result in electric shock, fire and/or serious injury. The term "power tool" in all of the warnings listed below refers to your mains-operated (corded) power tool or battery-operated (cordless) power tool.



SAVE THESE INSTRUCTIONS

1) Work area safety

- a) **Keep work area clean and well lit.** Cluttered or dark areas invite accidents.
- b) **Do not operate power tools in explosive atmospheres, such as in the presence of flammable liquids, gases or dust.** Power tools create sparks which may ignite the dust or fumes.
- c) **Keep children and bystanders away while operating a power tool.** Distractions can cause you to lose control.

2) Electrical safety

- a) **Power tool plugs must match the outlet. Never modify the plug in any way. Do not use any adapter plugs with earthed (grounded) power tools.** Unmodified plugs and matching outlets will reduce risk of electric shock.
- b) **Avoid body contact with earthed or grounded surfaces such as pipes, radiators, ranges and refrigerators.** There is an increased risk of electric shock if your body is earthed or grounded.
- c) **Do not expose power tools to rain or wet conditions.** Water entering a power tool will increase the risk of electric shock.
- d) **Do not abuse the cord. Never use the cord for carrying, pulling or unplugging the power tool. Keep cord away from heat, oil, sharp edges or moving parts.** Damaged or entangled cords increase the risk of electric shock.
- e) **When operating a power tool outdoors, use an extension cord suitable for outdoor use.** Use of a cord suitable for outdoor use reduces the risk of electric shock.

3) Personal safety

- a) **Stay alert, watch what you are doing and use common sense when operating a power tool. Do not use a power tool while you are tired or under the influence of drugs, alcohol or medication.** A moment of inattention while operating power tools may result in serious personal injury.
- b) **Use safety equipment. Always wear eye protection.** Safety equipment such as dust mask, non-skid safety shoes, hard hat, or hearing protection used for appropriate conditions will reduce personal injuries.
- c) **Avoid accidental starting. Ensure the switch is in the off-position before plugging in.** Carrying power tools with your finger on the switch or plugging in power tools that have the switch on invites accidents.

GENERAL SAFETY RULES continued

- d) **Remove any adjusting key or wrench before turning the power tool on.** A wrench or a key left attached to a rotating part of the power tool may result in personal injury.
- e) **Do not overreach. Keep proper footing and balance at all times.** This enables better control of the power tool in unexpected situations.
- f) **Dress properly. Do not wear loose clothing or jewelry. Keep your hair, clothing and gloves away from moving parts.** Loose clothes, jewelry or long hair can be caught in moving parts.
- g) **If devices are provided for the connection of dust extraction and collection facilities, ensure these are connected and properly used.** Use of these devices can reduce dust-related hazards.

4) Power tool use and care

- a) **Do not force the power tool. Use the correct power tool for your application.** The correct power tool will do the job better and safer at the rate for which it was designed.
- b) **Do not use the power tool if the switch does not turn it on and off.** Any power tool that cannot be controlled with the switch is dangerous and must be repaired.
- c) **Disconnect the plug from the power source before making any adjustments, changing accessories, or storing power tools.** Such preventive safety measures reduce the risk of starting the power tool accidentally.
- d) **Store idle power tools out of the reach of children and do not allow persons unfamiliar with the power tool or these instructions to operate the power tool.** Power tools are dangerous in the hands of untrained users.
- e) **Maintain power tools. Check for misalignment or binding of moving parts, breakage of parts and any other condition that may affect the power tools operation. If damaged, have the power tool repaired before use.** Many accidents are caused by poorly maintained power tools.
- f) **Keep cutting tools sharp and clean.** Properly maintained cutting tools with sharp cutting edges are less likely to bind and are easier to control.
- g) **Use the power tool, accessories and tool bits etc., in accordance with these instructions and in the manner intended for the particular type of power tool, taking into account the working conditions and the work to be performed.** Use of the power tool for operations different from those intended could result in a hazardous situation.











5) Service

- a) **Have your power tool serviced by a qualified repair person using only identical replacement parts.** This will ensure that the safety of the power tool is maintained.

ADDITIONAL SPECIFIC SAFETY RULES

1. **Hold power tools by insulated gripping surfaces when performing an operation where the cutting tool may contact hidden wiring or its own cord.** Contact with a "live" wire will make exposed metal parts of the tool "live" and shock the operator.
2. **Use clamps or other practical way to secure and support the workpiece to a stable platform.** Holding the work by hand or against your body is unstable and may lead to loss of control.
3. **DISCONNECT TOOL FROM POWER SOURCE** before making adjustments or changing bits.
4. **TIGHTEN COLLET NUT** securely to prevent the bit from slipping.
5. **USE A CLAMP** or some other device to hold the workpiece rigidly in position, and clear the path of the tool of obstructions.
6. **PROVIDE CLEARANCE** under workpiece for router bit when through-cutting.
7. **CHECK TO SEE THAT THE CORD** will not "hang up" during routing operation.
8. **CLEAR THE ROUTER BIT AREA** before starting motor.
9. **MAINTAIN FIRM GRIP** on router to resist starting torque.
10. **KEEP HANDS CLEAR OF BIT** when motor is running to prevent personal injury.
11. **KEEP CUTTING PRESSURE CONSTANT.** Do not overload motor.
12. **LET THE MOTOR COME TO A COMPLETE STOP** before putting the tool down.
13. **NEVER TOUCH** router bits after use. They may be extremely hot.
14. **NEVER TIGHTEN COLLET NUT** without a bit.
15. **DO NOT USE ROUTER BITS** with a diameter in excess of 2-1/2" at RPM above 13,000. Router bits up to 3-1/2" in diameter can be used when speed control is set for 13,000 RPM or less.
16. **ALWAYS KEEP CHIP SHIELD** clean and in place.
17. **AVOID "CLIMB-CUTTING"** (see "Using The Router" section in this manual). "Climb-cutting" increases the chance for loss of control resulting in possible personal injury.
18. **DO NOT HAND-HOLD THE ROUTER IN AN UPSIDE-DOWN OR HORIZONTAL POSITION.** The motor can separate from the base if not properly attached according to the instructions.
19. **Wear eye and hearing protection. Always use safety glasses.** Everyday eyeglasses are NOT safety glasses. USE CERTIFIED SAFETY EQUIPMENT. Eye protection equipment should comply with ANSI Z87.1 standards. Hearing equipment should comply with ANSI S3.19 standards.
20. **▲ WARNING** Use of this tool can generate and disburse dust or other airborne particles, including wood dust, crystalline silica dust and asbestos dust. Direct particles away from face and body. Always operate tool in well ventilated area and provide for proper dust removal. Use dust collection system wherever possible. Exposure to the dust may cause serious and permanent respiratory or other injury, including silicosis (a serious lung disease), cancer, and death. Avoid breathing the dust, and avoid prolonged contact with dust. Allowing dust to get into your mouth or eyes, or lay on your skin may promote absorption of harmful material. Always use properly fitting NIOSH/OSHA approved respiratory protection appropriate for the dust exposure, and wash exposed areas with soap and water.

SAVE THESE INSTRUCTIONS!

SYMBOL	DEFINITION
V	volts
A	amperes
Hz	hertz
W	watts
kW	kilowatts
F	farads
μF	microfarads
l	litres
g	grams
kg	kilograms
bar	bars
Pa	pascals
h	hours
min	minutes
s	seconds
n_0	no-load speed
.../min or ...min ⁻¹	Revolutions or reciprocations per minute
 or d.c.	direct current
 or a.c.	alternating current
2 	two-phase alternating current
2N 	two-phase alternating current with neutral
3 	three-phase alternating current
3N 	three-phase alternating current with neutral
 A	rated current of the appropriate fuse-link in amperes
 X	time-lag miniature fuse-link where X is the symbol for the time/current characteristic, as given in IEC 60127
	protective earth
	class II tool
IPXX	IP symbol

SAVE THESE INSTRUCTIONS!

MOTOR

Many Porter-Cable tools will operate on either D.C., or single phase 25 to 60 cycle A.C. current and voltage within plus or minus 5 percent of that shown on the specification plate on the tool. Several models, however, are designed for A.C. current only. Refer to the specification plate on your tool for proper voltage and current rating.

CAUTION Do not operate your tool on a current on which the voltage is not within correct limits. Do not operate tools rated A.C. only on D.C. current. To do so may seriously damage the tool.

EXTENSION CORD SELECTION

If an extension cord is used, make sure the conductor size is large enough to prevent excessive voltage drop which will cause loss of power and possible motor damage. A table of recommended extension cord sizes will be found in this section. This table is based on limiting line voltage drop to 5 volts (10 volts for 230 volts) at 150% of rated amperes.

If an extension cord is to be used outdoors, it must be marked with the suffix W-A or W following the cord type designation. For example – SJTW-A to indicate it is acceptable for outdoor use.

RECOMMENDED EXTENSION CORD SIZES FOR USE WITH PORTABLE ELECTRIC TOOLS

		Length of Cord in Feet									
		115V	25 Ft.	50 Ft.	100 Ft.	150 Ft.	200 Ft.	250 Ft.	300 Ft.	400 Ft.	500 Ft.
		230V	50 Ft.	100 Ft.	200 Ft.	300 Ft.	400 Ft.	500 Ft.	600 Ft.	800 Ft.	1000 Ft.
Nameplate Ampere Rating	0-2	18	18	18	16	16	14	14	12	12	
	2-3	18	18	16	14	14	12	12	10	10	
	3-4	18	18	16	14	12	12	10	10	8	
	4-5	18	18	14	12	12	10	10	8	8	
	5-6	18	16	14	12	10	10	8	8	6	
	6-8	18	16	12	10	10	8	6	6	6	
	8-10	18	14	12	10	8	8	6	6	4	
	10-12	16	14	10	8	8	6	6	4	4	
	12-14	16	12	10	8	6	6	6	4	2	
	14-16	16	12	10	8	6	6	4	4	2	
	16-18	14	12	8	8	6	4	4	2	2	
	18-20	14	12	8	6	6	4	4	2	2	

SAVE THESE INSTRUCTIONS!

CARTON CONTENTS

FOR THE MODEL 891 - Equipped with the router motor, Base, 1/4" collet, 1/2" collet, collet wrench, GripVac™ handle, and instruction manual.

FOR THE MODEL 892 - Equipped with the router motor, base, 1/4" collet, 1/2" collet, collet wrench, carrying case, and instruction manual.

FOR THE MODEL 8931 - Contents include the router base and an instruction manual.

FUNCTIONAL DESCRIPTION

FOREWORD

Porter-Cable routers are designed for continuous, rugged operation to handle the most demanding production applications.

ASSEMBLY

NOTE: This tool is shipped completely assembled. No assembly time or tools are required.

SELECTING THE BIT

The 891 series of routers accommodates bits with 1/4" and 1/2" diameter shanks. A collet is also available that will accommodate bits with 3/8" diameter shanks.

⚠ WARNING Use router bits with a diameter larger than 2-1/2" ONLY when the speed control is set between 10,000 and 13,000 RPM. The maximum diameter bit is 3-1/2".

⚠ WARNING Disconnect tool from power source when preparing the router for use, making adjustments, and when router is not in use.

INSTALLING AND REMOVING THE BIT (891 and 892)

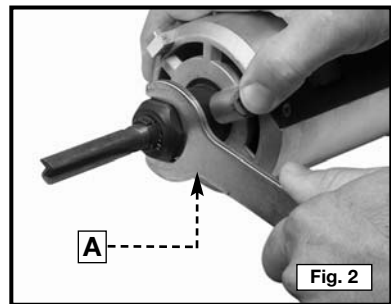
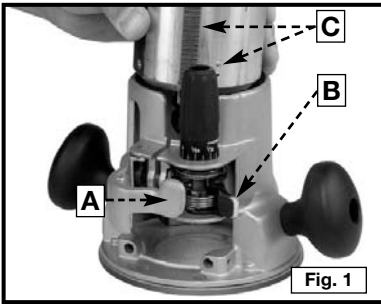

⚠ WARNING Disconnect the tool from the power source!

1. To remove the motor unit from the base unit:
 - (a) Open the clamp (A) Fig. 1.
 - (b) Lift the power unit free from the base unit.
2. Clean and insert the shank of the bit into the collet until the shank bottoms, then back it out approximately 1/16".
3. Lay the power unit on its side on a bench with the collet pointing **AWAY** from you.
4. Press the spindle lock button (A) Fig. 2.
5. Place the wrench on the collet and turn **CLOCKWISE** to tighten. Tighten firmly.
6. To remove the bit, reverse the procedure.

⚠ CAUTION Avoid possible damage to the collet. Never tighten the collet without a bit.

INSTALLING THE MOTOR

⚠ WARNING Disconnect the tool from the power source!

1. Open the clamp (A) Fig. 1 and set the power unit in the base unit.
2. Align the rack and pin (C) Fig. 1 of the power unit with the grooves in the base. Pull the lever (B) Fig. 1, and lower the motor into the base.
3. Close the clamp (A).
4. Reverse the procedure to remove.

ADJUSTING THE DEPTH OF CUT

⚠ WARNING Disconnect the tool from the power source!

1. Open the clamp (A) Fig. 3.
2. Pull the lever (B) and set the router on the workpiece. With the router flat and level, let the bit barely touch the workpiece.
3. Hold the lever (B) and turn the depth knob (C) until the zero aligns with the zero mark on the router base.
4. Release the lever (B). Make sure that the zero remains aligned with the zero mark.
5. Turn the knob (C) clockwise to the desired depth of cut.
6. Close the clamp (A).

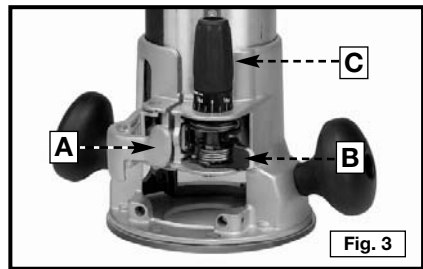

NOTE: Setting the index line to 1/16" on the knob indicates that the cutting edge of the bit is exposed 1/16" below the base.

ADJUSTING THE SUB-BASE ALIGNMENT (All Routers)

⚠ WARNING Disconnect the tool from the power source!

Applications using a templet guide require the bit to be centered in the guide. This, in turn, requires the center hole in the sub-base to be in line with the collet of the motor unit. Your model has an adjustable sub-base that has been aligned at the factory. The fixed-base router comes with the large hole (Fig. 4).

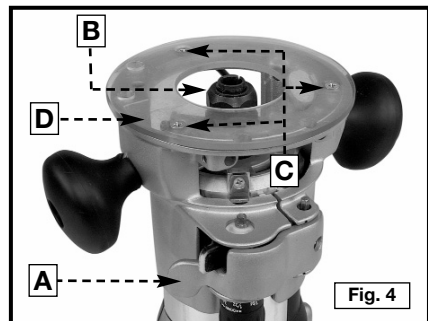

▲WARNING Disconnect the tool from the power source!

1. Loosen the sub-base mounting screws (C) Fig. 4 just enough to allow the sub-base (D) to move.
2. Open the clamp (A) Fig. 4, and adjust the power unit so that the collet nut (B) engages the center hole in the sub-base (D). Allow the sub-base to center itself on the collet nut. Close the clamp (A).
3. Tighten the sub-base mounting screws (C) Fig. 4 securely.

8931 PLUNGE BASE

VACUUM HOSE

A standard 1" vacuum hose (A) Fig. 5 can be attached to the dust port (B) Fig. 5 to connect the tool to a vacuum cleaner or dust collection system.

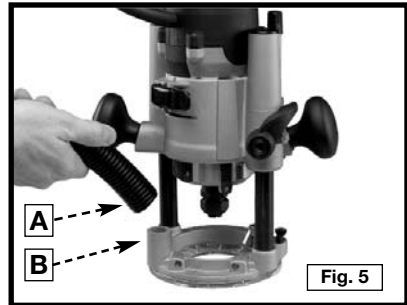

INSTALLING AND REMOVING THE BIT

▲WARNING Disconnect the tool from the power source!

1. Stand the router upside down on its motor cap (Fig. 6).
2. Clean and insert the shank of the bit into the collet until the shank bottoms. Then back it out approximately 1/16".
3. Press the spindle lock button (A) Fig. 6, and place a wrench on the collet nut (B) Fig. 6. Tighten firmly.
4. To remove the bit, reverse the procedure.

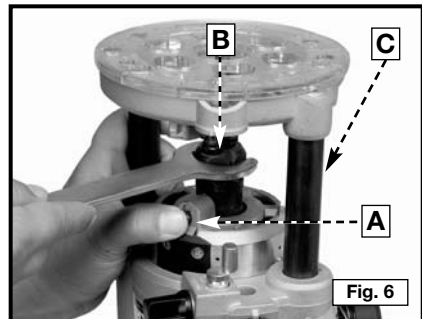

CAUTION

Do not allow the wrenches to contact the columns (C) Fig. 6. Columns could be damaged, restricting the plunge action.

CAUTION

Avoid possible damage to collet. Never tighten collet without a bit.

CAUTION

If you remove the springs from the posts (E) Fig. 7 to use the plunge base in a router table, remove the post plugs carefully. They are spring-loaded and should be removed only when the base housing is in the "up" position (Fig. 6).

ADJUSTING THE PLUNGE BASE

⚠ WARNING Disconnect the tool from the power source!

1. Loosen the depth rod locking knob (A) Fig. 7, and depth indicator knob (C) Fig. 7, allowing the depth rod (D) Fig. 7 to contact one of the turret stops (A) Fig. 8. Normally the deepest desired cut is set with the depth rod resting on the base casting (B) Fig. 7. The other three adjustable stops (A) Fig. 8 may be adjusted to any desired height. Any combination of fixed and/or adjustable stops may be utilized to achieve the desired depths required for a particular job. The adjustable stop (B) Fig. 8 will raise or lower that stop by $\frac{1}{32}$ " with one full turn of the stop.

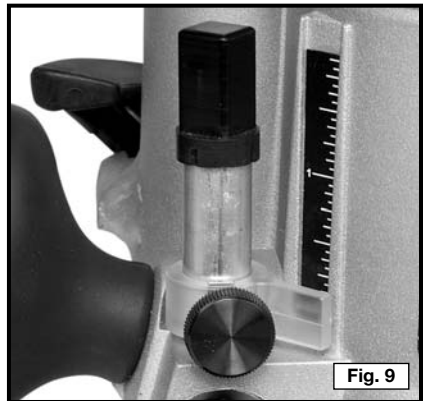
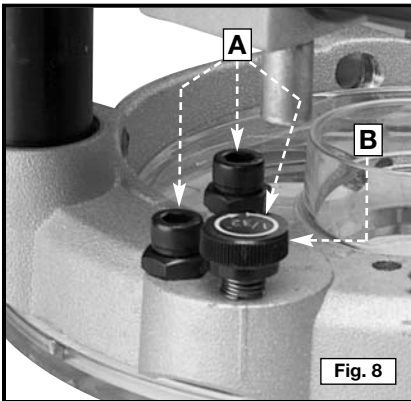
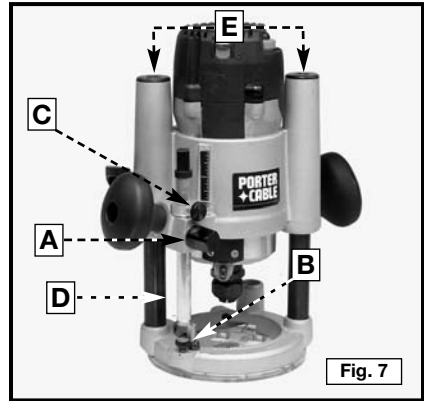

2. Release the plunge mechanism by pulling the locking lever (A) Fig. 10 down. Lower the plunge mechanism until the router bit touches the work surface. Release the lever and push it to the right to lock the mechanism in this position.
3. Tighten the depth-rod locking knob (A) Fig. 7.
4. Position the depth indicator (C) Fig. 10 at the "0" position and tighten the knob (C) Fig. 7.
5. Loosen the depth-rod locking knob (A) Fig. 7, and raise until the indicator aligns with the graduation representing the desired depth of plunge (Fig. 9).

ADJUSTING THE PLUNGE LOCKING LEVER

The plunge locking mechanism may be adjusted to compensate for wear, or to reposition lever (in locked position). To adjust:

⚠ WARNING Disconnect the tool from the power source!

1. Lock the plunge locking lever (A) Fig. 10 by moving it to your right as far as it will go.
2. Push in on the plunge locking lever (A) Fig. 10.
3. Move the plunge locking lever (A) Fig. 10 to the desired location and allow it to spring back into position.

NOTE: Pushing the plunge locking lever down past the last stop will place the router in the “free-plunge” mode.

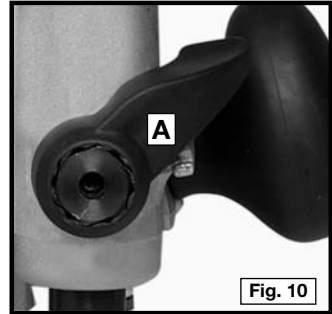

To adjust the plunge locking mechanism:

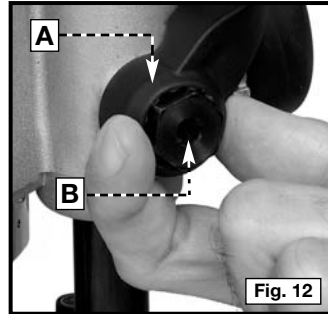
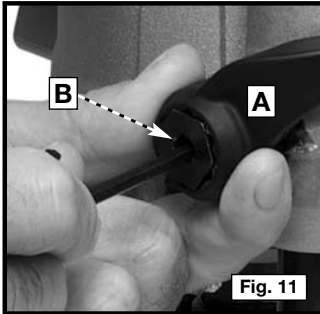

1. Hold the plunge locking lever (A) Fig. 11.
2. Insert an 1/8" hex wrench (not furnished) through the center of the plunge-locking bolt (B) Fig. 11 and into the adjustment screw. Turn the screw counter-clockwise approximately one turn.
3. Push in on the plunge locking lever (A) Fig. 12 to expose the head of the plunge-locking bolt (B) Fig. 12.
4. Hold the plunge-locking lever (A) Fig. 12 in. Turn the plunge-locking bolt (B) Fig. 12 clockwise to cause the plunge-locking bolt to move in or counter-clockwise to cause the plunge-locking bolt to move out. Turn it one position at a time until you achieve the correct adjustment.

NOTE: Adjustment is correct when the plunge-locking lever can be locked into the free motion position (Fig. 13) and into the plunge-locked position (Fig. 14).

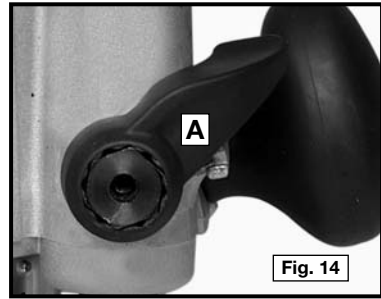
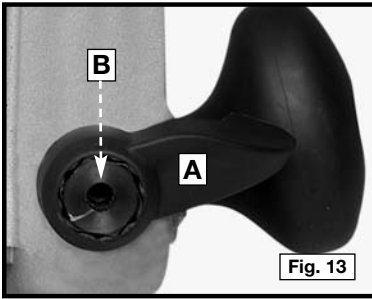

5. Move the plunge locking lever (A) Figs. 13 and 14 halfway between those two positions. Insert the hex wrench through the center of the plunge locking bolt (B) Fig. 13 into the adjustment screw. Turn clockwise to tighten.

OPERATION

STARTING AND STOPPING THE MOTOR

CAUTION Before starting the tool, clear the work area of all foreign objects. Keep a firm grip on the tool to resist starting torque.

Two switches (A and B) Fig. 15 turn this tool “ON” and “OFF”. Additionally, the upper switch (A) will automatically turn the tool “OFF” if the tool is placed upside down on a surface.

Turn the tool “ON” or “OFF” with lower switch (B) Fig. 15, using the thumb of the left hand while holding the tool (Fig. 16).

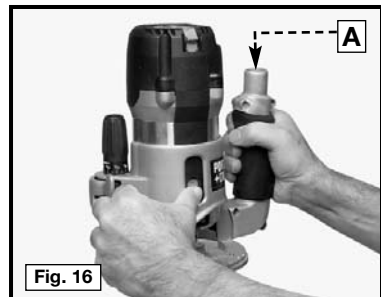
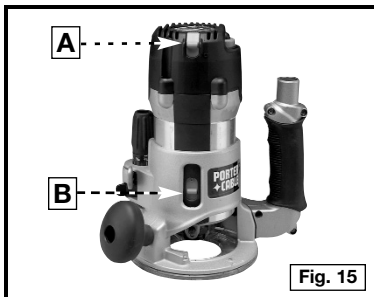

CAUTION To avoid injury and/or damage to finished work, always allow the motor to come to a COMPLETE STOP before putting the tool down.

NOTE: For convenient dust and chip collection, you can attach your shop vac to the GripVac™ unit by placing the hose on the GripVac handle (A) Fig. 16. See “ACCESSORIES”.

VARIABLE SPEED CONTROL

This router is equipped with a variable speed control (A) Fig. 17 with an infinite number of speeds between 10,000 and 23,000 RPM.

Adjust the speed by turning the speed control knob (A).

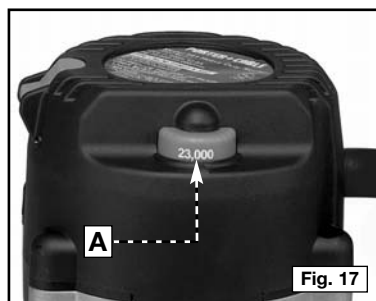

CAUTION In low and medium speed operation, the speed control prevents the motor speed from decreasing. If you expect to hear a speed change and continue to load the motor, you could damage the motor by overheating. Reduce the depth of cut and/or slow the feed rate to prevent tool damage.

USING THE TOOL

IMPORTANT: Before using the tool, consider the kind and amount of material to be removed. More than one cut may be necessary to avoid overloading the motor. Before beginning the cut on the actual workpiece, make a sample cut on a piece of scrap lumber. This will allow you to see the finished cut and to check dimensions.

CAUTION Always be sure the work is rigidly clamped or otherwise secured before making a cut.

Generally speaking, when working on a bench, hold the workpiece on the bench with wood clamps. When routing the edges, hold the router firmly down and against the work with both guiding handles.

Since the cutter rotates clockwise (when viewing router from top), move the router from left to right as you stand facing the work. When working on the inside of a templet, move the router in a clockwise direction.

When working on the outside of a templet, move the router in a counter-clockwise direction.

WARNING Avoid “Climb-Cutting” (cutting in direction opposite that shown in Fig. 18). “Climb-Cutting” increases the chance for loss of control resulting in possible injury. When “Climb-Cutting” is required (backing around a corner), exercise extreme caution to maintain control of router. Make smaller cuts and remove minimal material with each pass.

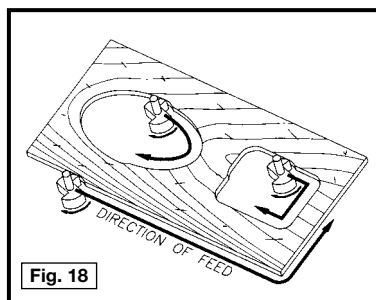

The speed and depth of cut will depend largely on the workpiece. Keep the cutting pressure constant but do not crowd the router so that the motor speed slows excessively. On exceptionally hard woods or problem materials, more than one pass at various settings may be necessary to get the desired depth of cut.

When making cuts on all four edges of the workpiece, make the first cut on the end of the piece across the grain. If chipping of wood occurs at the end of a cut, it will be removed when making the next cut parallel with the grain.

Periodically wipe the columns clean with a dry cloth. Clean the rack and gear on the fixed base with a soft bristle brush. Do not lubricate either the columns or the rack and gear.

THE EDGE GUIDE

An edge guide (Fig. 19) is available as an accessory to aid in routing operations such as straight edge planing, parallel grooving, dado, or slotting operations.

See “**ACCESSORIES**”

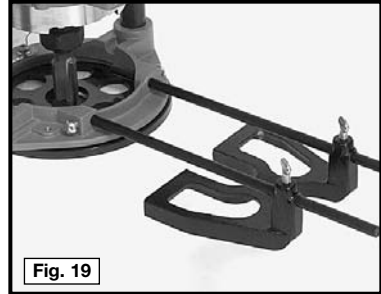
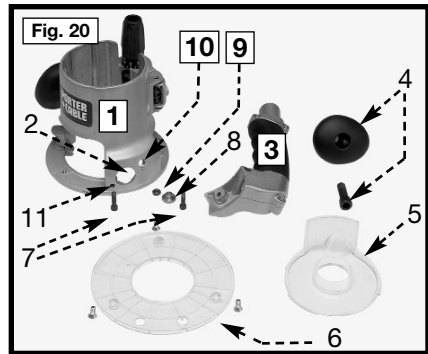

Fig. 19

GRIPVAC™ PARTS

1. Router base
2. Dust port
3. GripVac handle
4. Removed handle and screw
5. Dust deflector
6. Sub-base with screws
7. Hex screw (2)
8. Shoulder washer
9. Hex nut



INSTALLING THE OPTIONAL GRIPVAC™ (892)

1. Use a 5/16" hex wrench to loosen the screw in the handle (A) Fig. 21. Remove the handle from the router base. Place the handle and screw aside for use later if needed.
2. Remove the plastic plug from the dust port (2) Fig. 20.

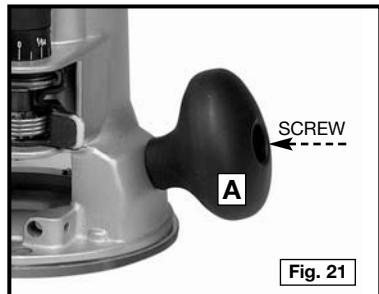
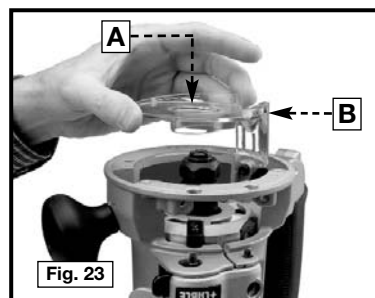
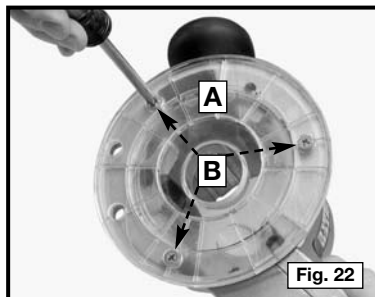

Fig. 21

3. Remove the screws (B) Fig. 22 and remove the sub-base (A).
4. Align the holes of the GripVac™ handle to the holes of the router base (10) Fig. 20.
5. Insert a hex screw (7) Fig. 20 through the handle into the hole (10). From inside the base housing, place a shoulder washer (8) and a hex nut (9) on the screw. Tighten the nut loosely.
6. From inside the base housing, insert the second screw (7) Fig. 20 into the hole (11) and screw it into the threaded hole of the GripVac™ handle.
7. Turn the router base upside down and place the dust deflector (A) Fig. 23 into the bottom of the router base by aligning the three plastic tabs on the deflector with the three recesses in the base. Align the extended part (B) Fig. 23 of deflector with GripVac™ handle. The deflector will be flush with bottom of router base.
8. Replace the sub-base and the three screws.
9. Tighten all hardware securely.
10. Connect any vacuum or dust collection system with a 1" hose to the Grip Vac™ (Fig. 24).



SOFT START

This router has a “Soft Start” feature designed to minimize startup reaction torque.

TEMPLER GUIDES

A wide variety of templet guides is available for use in pattern and templet routing operations. A typical combination bit, templet guide, and locknut are illustrated in Fig. 25.

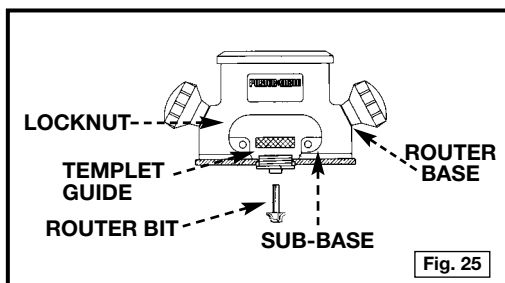

INSTALLING THE TEMPLATE GUIDES

▲WARNING Disconnect the tool from the power source!

insert the templet guide in the center hole of the router base and secure it in place with a locknut. Before connecting the router to the power source, install the bit, adjust the depth of cut, and rotate the router chuck by hand to ensure that the bit or collet do not contact the templet guide.

USING A ROUTER ACCESSORY TABLE

The router can be mounted to a router accessory table (not included). For instructions on how to mount the router to the router accessory table, refer to the accessory table instruction manual.

TROUBLESHOOTING

For assistance with your tool, visit our website at www.porter-cable.com for a list of service centers or call the Porter-Cable help line at 1-800-487-8665.

MAINTENANCE

KEEP TOOL CLEAN

Periodically blow out all air passages with dry compressed air. All plastic parts should be cleaned with a soft damp cloth. NEVER use solvents to clean plastic parts. They could possibly dissolve or otherwise damage the material.

▲WARNING Wear ANSI Z87.1 safety glasses while using compressed air.

FAILURE TO START

Should your tool fail to start, check to make sure the prongs on the cord plug are making good contact in the outlet. Also, check for blown fuses or open circuit breakers in the line.

LUBRICATION

This tool has been lubricated with a sufficient amount of high grade lubricant for the life of the unit under normal operating conditions. No further lubrication is necessary.

BRUSH INSPECTION (If applicable)

For your continued safety and electrical protection, brush inspection and replacement on this tool should ONLY be performed by an AUTHORIZED PORTER-CABLE SERVICE STATION or a PORTER-CABLE•DELTA FACTORY SERVICE CENTER.

At approximately 100 hours of use, take or send your tool to your nearest authorized Porter-Cable Service Station to be thoroughly cleaned and inspected. Have worn parts replaced and lubricated with fresh lubricant. Have new brushes installed, and test the tool for performance.

Any loss of power before the above maintenance check may indicate the need for immediate servicing of your tool. DO NOT CONTINUE TO OPERATE TOOL UNDER THIS CONDITION. If proper operating voltage is present, return your tool to the service station for immediate service.

SERVICE

REPLACEMENT PARTS

When servicing use only identical replacement parts. For a service parts list or to learn more about Porter-Cable visit our website at www.porter-cable.com.

SERVICE AND REPAIRS

All quality tools will eventually require servicing, or replacement of parts due to wear from normal use. For assistance with your tool, visit our website at www.porter-cable.com for a list of service centers or call the Customer Care Department at 1-800-487-8665. All repairs made by our service centers are fully guaranteed against defective material and workmanship. We cannot guarantee repairs made or attempted by others.

Should you have any questions about your tool, feel free to write us at any time. In any communications, please give all information shown on the nameplate of your tool (model number, type, serial number, etc.).

ACCESSORIES

A complete line of accessories is available from your Porter-Cable•Delta Supplier, Porter-Cable•Delta Factory Service Centers, and Porter-Cable Authorized Service Stations. Please visit our Web Site www.porter-cable.com for a catalog or for the name of your nearest supplier.

⚠ WARNING Since accessories other than those offered by Porter-Cable•Delta have not been tested with this product, use of such accessories could be hazardous. For safest operation, only Porter-Cable•Delta recommended accessories should be used with this product.

WARRANTY

WARRANTY REGISTRATION

To register your tool for warranty service visit our website at www.portercable.com.

PORTER-CABLE LIMITED ONE YEAR WARRANTY

Porter-Cable warrants its Professional Power Tools for a period of one year from the date of original purchase. We will repair or replace at our option, any part or parts of the product and accessories covered under this warranty which, after examination, proves to be defective in workmanship or material during the warranty period. For repair or replacement return the complete tool or accessory, transportation prepaid, to your nearest Porter-Cable Service Center or Authorized Service Station. Proof of purchase may be required. This warranty does not apply to repair or replacement required due to misuse, abuse, normal wear and tear or repairs attempted or made by other than our Service Centers or Authorized Service Stations.

ANY IMPLIED WARRANTY, INCLUDING THE IMPLIED WARRANTIES OF MERCHANTABILITY AND FITNESS FOR A PARTICULAR PURPOSE, WILL LAST ONLY FOR ONE (1) YEAR FROM THE DATE OF PURCHASE.

To obtain information on warranty performance please write to: PORTER-CABLE, 4825 Highway 45 North, Jackson, Tennessee 38305; Attention: Product Service. THE FOREGOING OBLIGATION IS PORTER-CABLE'S SOLE LIABILITY UNDER THIS OR ANY IMPLIED WARRANTY AND UNDER NO CIRCUMSTANCES SHALL PORTER-CABLE BE LIABLE FOR ANY INCIDENTAL OR CONSEQUENTIAL DAMAGES. Some states do not allow limitations on how long an implied warranty lasts or the exclusion or limitation of incidental or consequential damages, so the above limitation or exclusion may not apply to you.

This warranty gives you specific legal rights and you may also have other legal rights which vary from state to state.

The following are trademarks of PORTER-CABLE • DELTA (Las siguientes son marcas registradas de PORTER-CABLE • DELTA S.A.) (Les marques suivantes sont des marques de fabricant de la PORTER-CABLE • DELTA): Auto-Set[®], BAMMER[®], B.O.S.S.[®], Builder's Saw[®], Contractor's Saw[®], Contractor's Saw II[™], Delta[®], DELTACRAFT[®], DELTAGRAM[™], Delta Series 2000[™], DURATRONIC[™], Emc^{2™}, FLEX[®], Flying Chips[™], FRAME SAW[®], Grip Vac[™], Homecraft[®], Jet-Lock[®], JETSTREAM[®], 'kickstand[®], LASERLOC[®], MICRO-SET[®], Micro-Set[®], MIDI LATHE[®], MORTEN[™], NETWORK[™], OMNIJIG[®], POCKET CUTTER[®], PORTA-BAND[®], PORTA-PLANE[®], PORTER-CABLE[®]&(design), PORTER-CABLE[®]PROFESSIONAL POWER TOOLS, PORTER-CABLE REDEFINING PERFORMANCE[™], Posi-Matic[®], Q-3[®]&(design), QUICKSAND[®]&(design), QUICKSET[™], QUICKSET II[®], QUICKSET PLUS[™], RIPTIDE[™]&(design), SAFE GUARD II[®], SAFE-LOC[®], Sanding Center[®], SANDTRAP[®]&(design), SAW BOSS[®], Sawbuck[™], Sidekick[®], SPEED-BLOC[®], SPEEDMATIC[®], SPEEDTRONIC[®], STAIR EASE[®], The American Woodshop[®]&(design), The Lumber Company[®]&(design), THE PROFESSIONAL EDGE[®], THE PROFESSIONAL SELECT[®], THIN-LINE[™], TIGER[®], TIGER CUB[®], TIGER SAW[®], TORQBUSTER[®], TORQ-BUSTER[®], TRU-MATCH[™], TWIN-LITE[®], UNIGUARD[®], Unifence[®], UNIFEEDER[™], Unih[®]head[®], Uniplane[™], Unirip[®], Unisaw[®], Univise[®], Versa-Feeder[®], VERSA-PLANE[™], WHISPER SERIES[®], WOODWORKER'S CHOICE[™].

Trademarks noted with [™] and [®] are registered in the United States Patent and Trademark Office and may also be registered in other countries. Las Marcas Registradas con el signo de [™] y [®] son registradas por la Oficina de Registros y Patentes de los Estados Unidos y también pueden estar registradas en otros países. Marques déposées, indiquées par la lettre [™] et [®], sont déposées au Bureau des brevets d'invention et marques déposées aux Etats-Unis et pourraient être déposées aux autres pays.

PORTER♦CABLE[®]

4825 Highway 45 North

Jackson, TN 38305

1-888-848-5175

www.porter-cable.com