

(20761, 22719)

# *ONEWAY & TALON*

## *4 Jaw Safety Scroll Chucks*

---

ONEWAY CHUCK  
(LEVER OPERATED)

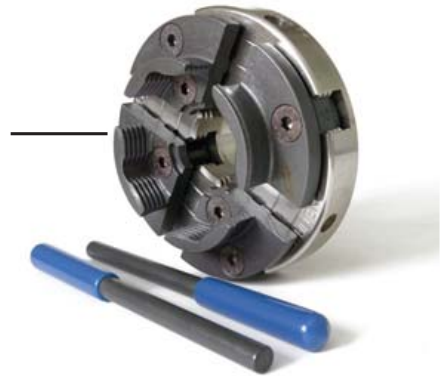

TALON CHUCK  
(KEY OPERATED)

### *Instruction Manual*

Congratulations on your purchase. We at ONEWAY believe that you will be pleased with either your new ONEWAY Lever Operated chuck or your Talon Key Operated Chuck. Please read the following instructions before its use.

## TABLE OF CONTENTS:

<u>Page</u>	<u>Page</u>
<b>SECTION 1 - Your Chuck &amp; its parts</b>	<b>Specifications for Chucking</b>
3 Contents of this package	16-18 <b>SECTION 4 - Chuck Accessories</b>
4-5 Chuck Description	16 Optional Chuck Accessories & Uses
6 Features of your Chuck	Capacity Chart
7 Installing the Woodworm Screw	19 <b>SECTION 5 - Turning Tips</b>
7 Profile Jaw Shape	19 Methods for turning Bowls/Platters:
8 Why you have bought a superior chuck	20 <i>Method One:</i> Screw chucking
<b>SECTION 2 - Getting Started</b>	20-21 <i>Method Two:</i> Large Drill
9 <b>Started</b>	21 <i>Method Three:</i> Glue Block
9-10 Mounting the Adaptor	Differentiating Left & Right Hand
10 Removing the Adaptor	22 Screws
Mounting the Chuck on your lathe spindle	22 Maximizing Gripping Power
11 <b>SECTION 3 - Maintenance</b>	23 A Finishing Tip
11 Removing Top Jaws	24-25 Popular Method for Bowl Turning
12-14 Removing Base Jaws	Safety Tips
15 Reassembling your Chuck	26
	27 Manufacturers Warranty
	Warranty Card.

## SECTION 1 - YOUR CHUCK & ITS PARTS

---

### CONTENTS OF THIS PACKAGE

Please check that the following components are included in your package. If any of the pieces are missing, please contact the place of purchase immediately.

\* The adaptor may be packaged separately. If your adaptor is not already installed in your chuck, installation instructions are on page 9.

#### **ONEWAY CHUCK**

- ONEWAY Chuck with #2 Jaws Attached
- Levers (2)
- 1-1/2" R.H. Jumbo Screw (1)
- M4 \* 16 Hex Socket Screws (3)
- 4 mm T-handle Hex Key (1)
- 3 mm Hex Key (1)
- Taperlock Adaptor\* (1)

#### **TALON CHUCK**

- Talon Chuck with #2 Jaws Attached
- Geared Chuck Key & Cross Bar (1)
- Yellow Caps (for key assembly) (2)
- 1-1/2" R.H. Jumbo Screw (1)
- M4 \* 16 Hex Socket Screws (3)
- 4 mm T-handle Hex Key (1)
- 3 mm Hex Key (1)
- Taperlock Adaptor\* (1)

Certain features of ONEWAY chucks are patented under one or more of the following patent numbers: 5141239, 2257068, 5464231

(other patents pending at the time of printing this manual)

This section explains the proper terms for the component parts which make up your new Chuck. These terms will be referred to throughout this instruction manual. It is necessary that you know the proper names for the parts of your chuck for complete understanding of these instructions. Some of the chuck's features are also discussed.

## YOUR CHUCK DESCRIPTION

*Top view a ONEWAY chuck. It is shown partially disassembled to help illustrate all of its components.*

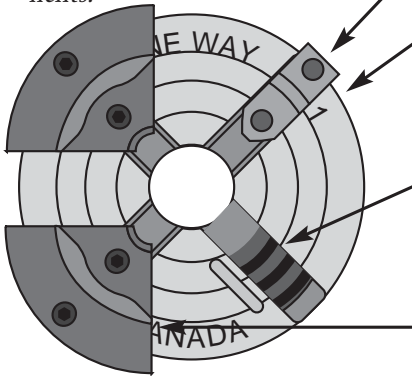

**BASE JAWS:** The carriers to which the top jaws are attached with two screws. They are numbered 1 through 4 on the side.

**BODY:** The main part of the chuck. It holds all other parts as an assembly.

**THE SCROLL:** The cylindrical part which has a flat surface thread on the top side which moves the base jaws in and out in unison.

**PROFILED TOP JAWS:** The No. 2 Jaws which are attached to the base jaws and will hold the wood to be turned.

**TAPERLOCK ADAPTOR:** Made with various threaded sizes so it can be made to fit any lathe spindle. If you change lathes, all you need to do is buy a new adaptor, not a whole new chuck. The taperlock design eliminates the possibility of the adaptor loosening or separating from the chuck body in normal use or when reversing the lathe.



## YOUR CHUCK DESCRIPTION

### NOT SEEN:

- \* **SNAP RING:** The clip which holds the scroll in place. Snap ring pliers (or similar) are required to remove the scroll if necessary
- \* **4mm T-HANDLE HEX KEY:** Used to install or remove Top Jaws.
- \* **3mm HEX KEY:** Used to install or remove the taper lock adaptor.

### TO OPEN AND CLOSE THE CHUCK:

#### ONEWAY

**2 LEVERS:** The levers and scroll are hardened to prevent the levers bending and the holes mis-shaping. Levers are made from high strength steel and will not deform or bend with normal use: it is important that when applying pressure that they are fully inserted in the hole. Failure to do so may cause elongation of the holes in the chuck body or scroll.

#### TALON

**GEARED KEY:** The key is supported in two places, for easy action and long life. Your key will come disassembled. Insert the cross bar into the hole in the key and put the Yellow End Caps (which are packed in a small plastic bag) on each end to secure it in place.



## FEATURES OF YOUR CHUCK

**JAWS** - ONEWAY Chucks are equipped with *ONEWAY's* patented profile top jaw shape. This shape increases gripping power at all diameters of round and square stock. Less wood damage also occurs with this jaw shape than with the conventional round shaped jaws.

*Note the recess:* This is where the groove around the diameter of the head of the screw fits. This eliminates the possibility of the screw moving in or out of the chuck.

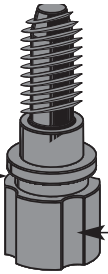

*Note the shape of the tip of the base jaw:* this fits into the grooves or flats that are milled along the length of the head of the screw which prevents the screw from spinning.

The groove on the base jaw is tapered. This groove is where the Top Jaw sits and is pulled in with two countersunk screws.

The taper allows for the top jaws to have a snug fit but will not damage either the top or base jaw.

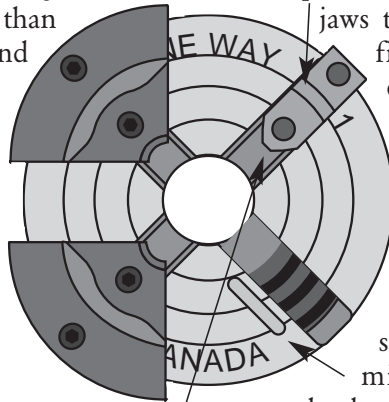

**S L O T** (patented safety feature) This is a slot which is milled onto the

body of the chuck. There is a shorter slot under the opposite jaw, which can't be seen in this view. Refer to page 14 for the functions of these slots.

## INSTALLING THE WOODWORM SCREW

View as to how the woodworm screw is mounted. Note the top jaw enters the groove to prevent pull out.

The base jaw enters the vertical groove which prevents spin. Two way retention - a *ONEWAY* invention, now copied by others.

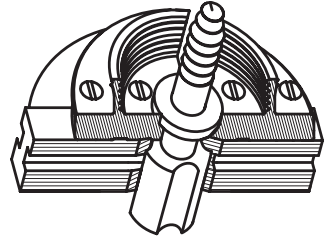

## A WORD ON *ONEWAY* PROFILE JAWS

Chucks and jaws are always a compromise. If you plan to always make one size bowl with the same shape foot then a system can be designed that will not damage your bowl's foot. There are many excellent quality chucks on the market. All of those chucks have one thing in common; their jaws were designed to fit only one diameter by a limited depth. This is called the design diameter. For example, a set of jaws turned to 2" diameter with a 7° taper \* 1/4 deep will only work well in a cavity that is exactly 2" diameter \* 7° and just less than 1/4" deep. They will hold progressively less, and increasingly damage your mounting as this base size changes from the theoretical perfect size. The *ONEWAY* wave pattern on the inside changes all that. Excellent 8 point contact is achieved at all diameters in the jaw size range used. On the outside (for in cavity chucking) the bite machined just short of the jaw end puts chucking pressure to the cavity bottom - the safest place to prevent breaking the cavities edge.

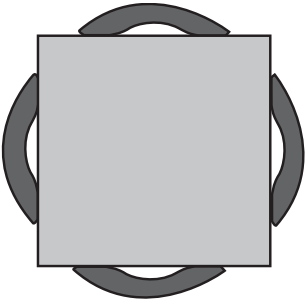

## WHY YOU HAVE BOUGHT A SUPERIOR CHUCK BY BUYING A ONEWAY MANUFACTURED CHUCK

- Base jaws are made from carbon steel. Precision grinding on the sides provides for the exact and controlled clearances which are required for wood turning chucks.
- Base jaws are case hardened which makes them longer lasting, stronger, and non-seizing in use.
- Scroll is precision machined and case hardened. The bore is honed to exact tolerances after heat treating.
- The scroll is manganese phosphate plated which acts as an anti-seize compound. Less lubrication is consequently required for smooth running action over the life of the chuck.
- The body is precision machined. Electroless nickel plating provides a hard wearing surface for base jaws and scroll while giving the added bonus of providing excellent corrosion resistance.

Add these quality materials and precision processes to features such as:

- Profiled Top Jaws
- Patented Safety Feature allowing maximum travel
- Superior taperlock adaptor
- Its one-of-a-kind woodworm screw

all at a competitive price - gives you an absolutely superior chuck.



## SECTION 2 - GETTING STARTED

### MOUNTING AND REMOVING THE ADAPTOR

Note that there are five holes in the adaptor. Three of these holes are not threaded. These are used to pull the adaptor into the tapered chuck body (and hold it there). The other two holes are threaded. These are used as jack screws if the adaptor needs to be removed.

- MOUNTING THE ADAPTOR*:- (the adaptor may already be mounted)
1. Wipe the inside of the taper of the chuck body as well as the outside of the adaptor to be sure all grit and dirt is removed.
  2. Slide the adaptor into the chuck body with the three holes of the adaptor lined up with the threaded holes of the chuck body.
  3. Thread in the M4 x 16 hex socket screws with the 3 mm hex key and tighten them alternately. Alternate tightening ensures that the adaptor is pulled into the taper straight.

After mounting the adaptor to the chuck, a space of 0.020 to 0.050 between the adaptor and the chuck body is normal.

### *REMOVING THE ADAPTOR*

1. Remove the three tightening screws and thread them into the two tapped holes of the adaptor. They now become jack screws.
2. Carefully tighten alternately until the adaptor pops loose from the taper.

**CAUTION:** If a lot of force is required to remove the adaptor, the screws may flatten and compress the first thread. After the adaptor is out of the chuck body, you may not be able to remove the screws from the adaptor. Do not forcibly remove, but take the following action: first turn the screws in further; then, using a file or grinder, remove the first squashed thread. You will now be able to remove the screws without damaging the taperlock adaptor.

#### **MOUNTING THE ONEWAY ON YOUR LATHE**

It is important that the chuck is put on your lathe properly. Proceed as follows:

After mounting the adaptor to the chuck, carefully screw the assembly onto your lathe spindle. It should go on smoothly without excessive play or binding. Screw it all the way on until the adaptor face contacts the spindle shoulder. Next, lock your spindle, and unscrew the chuck just slightly so you can give it a firm swift spin, consequently snapping the chuck home. Alternatively, a piece of wood can be tightened in the top jaws crosswise, and with the palm of your hand, bump the chuck home.

To remove, reverse the above procedure.

## SECTION 3 - MAINTENANCE

To clean your chuck, simply brush clean. If it is sticky, soak in varsol or mineral spirits with about 10% oil added. Allow to sit for 1/2 hour or more, and blow clean.

### TO DISASSEMBLE YOUR CHUCK

1. **Remove Top Jaws.** You may want to remove the Top Jaws either for cleaning purposes, or to exchange them for an optional set of jaws, with a different capacity. To remove the Top Jaws, use the 4mm T-Handle hex key and unscrew the eight screws counterclockwise. The jaws are pulled in on a taper, so after the screws are out, it is usually necessary to give them a tap (with the T-handle of the hex key) to knock them loose from the taper. It is possible to disassemble the chuck and leave three of the Top Jaws on - just locate the Top Jaw with the pin (#2 or #4), and remove it.
2. **Remove Base Jaws.** To remove the base jaws, you must remove at least one of the Top Jaws. All four Top Jaws can be removed, but for cleaning purposes, it is usually only necessary to remove one - that being the one with the pin (this may be No 2 or No 4 depending on if it is located in the short or long slot respectively). After this Top Jaw is off, open the chuck until the jaws stop moving. When the jaws are no longer moving, they are loose from the scroll and can be slid from the slots out of the body.
3. **Remove the adaptor** (refer to page 9). It is necessary to remove the adaptor in order to remove the snap ring.

4. **Remove the snap ring.** Use external snap ring pliers (or similar) for the ONEWAY or a screwdriver for the Talon to remove the snap ring.
5. After removing the snap ring, turn the chuck upside down into your hand and the scroll should fall straight out. ONEWAY chucks are manufactured with very tight tolerances, and sometimes a little jiggling is necessary to get the scroll out. Note: Do not use a wire brush on the scroll. This can damage the lubricating properties on the surfaces.

#### TO RE-ASSEMBLE YOUR ONEWAY

1. Place the scroll back into the chuck body.
2. Replace the snap ring.
3. Remount the base jaws, using the following directions:

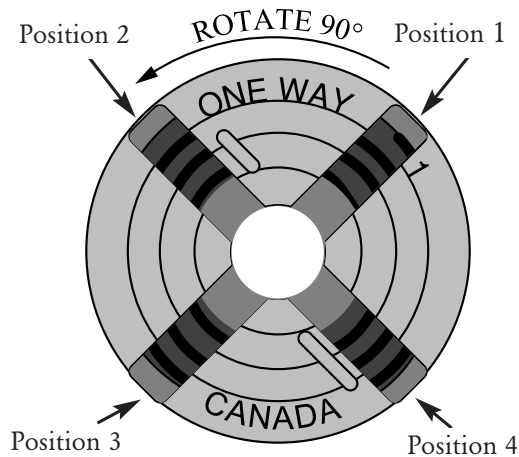

#### To Remount Base Jaws

- a. Rotate the scroll until you can see the thread start at pos.1.
- b. Back the scroll up until the start of the thread just disappears, and slide the No. 1 base jaw into the slot.
- c. While pushing inward on the No. 1 base jaw, rotate the scroll 90°. Pull outward on the No. 1 base jaw to make sure that it has engaged prop-

12 *Chuck shown with all jaws removed.*

erly with the scroll. If the jaw comes out, start the process again.



*ONEWAY with Top Jaws removed. After replacing base jaws, you must check that they all meet in the centre.*

d. Rotate the scroll until you can see the thread start at position 2.

e. Back the scroll up and slide the No. 2. base jaw into the slot. Push on the jaw, and rotate the scroll, as you did for the No. 1 base jaw.

f. Repeat these steps for the No. 3 and No. 4 base jaws.

g. Rotate the scroll all the way in to check that all the jaws meet in the centre. If they don't, you may have put the base jaws onto the scroll in the wrong order, or into the wrong slots, or one of the jaws may not have engaged properly onto the scroll. If the jaws do not meet in the centre, open the scroll until the jaws come out, and give it another try.

#### TROUBLESHOOTING:

If , after a second try, the jaws do not close properly, remove them and inspect for damage. It is possible that through accidental mishandling, the first half tooth on base jaw No. 1 has broken off. If this has happened, repeat the process above, but start by inserting base jaw No. 2 first, then No. 3, No. 4 and finally No. 1.

#### 4. **Re-attach Top Jaws** using the following directions:

##### Replacing Top Jaws:

To replace the Top Jaws on your Chuck, first make sure that both the top of the base jaw (still in the chuck) and the bottom of the Top Jaw (to be put on) are free of dirt. Next, locate the Top Jaw with the safety pin. Place it on the base jaw adjacent to the slot (patented feature) and replace the screws. After the top jaw with the pin is mounted on the chuck, the other three top jaws can be placed on the chuck body at random (making sure that all the contact surfaces are free of dirt).

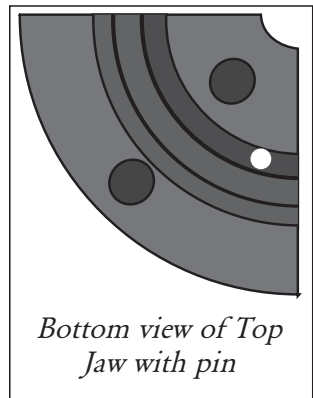

*There are **two** slots:*

**The Long Slot** is for experienced turners. It is machined to allow the jaws maximum outward travel without the base jaws coming out of the scroll, effectively preventing jaw fly-out when the lathe is started.

**The Short Slot** is for beginners and school use. This slot is machined to stop base jaws from protruding out of the chuck, which can be a hazard to knuckles when working close to the chuck.

#### 5. **Re-Mount the Adaptor.** (refer to page 9)

## SPECIFICATIONS FOR CHUCKING

### FOOT SPECIFICATIONS FOR BOARD GRAIN

When gripping the outside of a foot:

Min Dia 2.0"      Min Depth  $\frac{3}{16}$ "  
Max Dia 3-1/2"      Max Depth  $\frac{15}{32}$ "

1. Make the foot  $\frac{1}{4}$ " deep or more,
2. Stop off the top of the jaws, do not make the spigot so long that it reaches the bottom of the jaws and make the corner sharp. Make the foot straight.

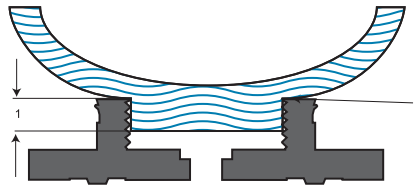

---

### TENON SPECS FOR BOARD GRAIN

Min Dia 2-3/8"      Min Depth  $\frac{1}{8}$ "  
Max Dia 4.0"      Max Depth  $\frac{7}{32}$ "

1. Do not make the cavity too deep. Maximum, depth should be  $\frac{7}{32}$ ". If you go as deep as the straight section on the outside of the jaws the jaws will grip very poorly.
2. Back taper  $2^\circ$  or  $3^\circ$  - the jaws will hold much better in a straight sided cavity than they will in a cavity that has too much taper.

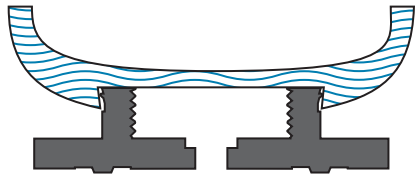

---

When gripping round end grain stock, make the spigot the same shape as for board grain.

Min. Dia. 2.0"      Min Depth  $\frac{3}{16}$ "  
Max. Dia. 3-1/2"      Max Depth  $\frac{15}{32}$ "

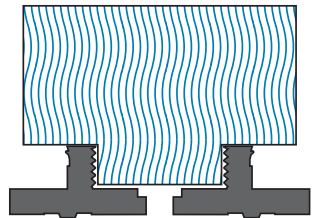

CAPACITY CHART

		ONEWAY Chuck		TALON Chuck	
		min	max	min	max
<b>Step Jaws</b> (for the Oneway & Talon chuck)	A	3/8	2	3/8	1
	B	7/8	2 ^	7/8	2-3/8
<b>Spigot Jaws</b> (for the Oneway chuck)	A		1	-	-
	B	1-1/16	2 ^	-	-
<b>**Spigot Jaws</b> (for the Talon chuck)	A	-	-	3/8	1-5/8
	B	-	-	1	2-3/8
<b>#2 Jaws</b> (for both Chucks)	A	1-5/8	3	1-5/8	2-7/8
	B	2	3-5/8	2	3 ^
<b>Dovetail Jaws</b> (for both Chucks)	A	1-5/8	3	1-5/8	2-7/8
	B	2	3-5/8	2	3 ^
<b>#3 Jaws</b> (for the Oneway chuck)	A	-	-	2-7/8	4
	B	-	-	3-3/8	4-5/8
<b>Jumbo Jaws</b> (for both Chucks)	A	2-7/8	11	2-7/8	10
	B	4-7/8	12	4-7/8	11

A = External or compression chucking

B = Internal or expansion chucking

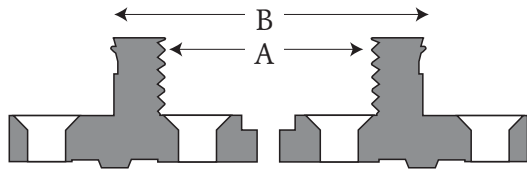

\*\* will only fit ONEWAY Chucks manufactured with zig-zag base jaw design. To double check, remove top jaws-if base jaws have 3 holes, these jaws will fit

ONEWAY reserves the right to change specifications without notice.



## **SECTION 4 - ONEWAY & TALON ACCESSORIES**

Right out of the box, your chuck will be ready to be used for most turning applications. The accessories which *ONEWAY* offers were designed to allow the wood turner to take on projects which may require a smaller or larger capacity than what the standard No. 2 Jaws can handle. The following is a list of available accessories which will allow you to easily upgrade and diversify your Chuck.

### **NO. 1 JAWS**

If often turning small parts, No. 1 jaws are a must, but do not use them for material over 1-1/2" in diameter or for bowls with recess larger than 1-3/4" in diameter. (Step Jaws & Spigot Jaws available)

### **DOVETAIL JAWS**

These jaws have the same capacities as the standard #2 Jaws which come with the chuck. The inside and outside surface of the jaws is smooth and are designed and recommended for light cutting applications. These jaws will not mark you work piece as much as the standard supplied jaws, but they also will not grip with the same power.

### **NO. 3 JAWS**

For large bowls (over 12" in diameter and 5" deep), No. 3 jaws are an asset because their larger size will better support your material, whether holding inside or out.

### **FLAT JAWS**

These are low cost jaws on which wooden blocks can be mounted. These blocks can be turned providing a custom grip jaw set.

### **JUMBO JAWS**

For finishing the backside of your bowls up to 12" in diameter, the

Jumbo Jaws are unsurpassed. Jumbo Jaws are aluminum plates machined from the solid for higher strength. Buttons are hard rubber sleeves pressed on taper steel cores and can be positioned at virtually any diameter.

### **MINI JUMBO JAWS**

These jaws come in a smaller 8-1/2" diameter. Because of their smaller size, they can easily be used on most mini or small sized lathes.

### **EXTRA BUTTON SET**

For large, or odd shaped bowls, an extra button set is available which allows buttons to be stacked.

### **JUMBO SCREWS**

An 1-1/2" Left Hand Jumbo Screw is available for outboard turning (this screw is the same length as the R.H. screw which is supplied with the chuck). For large bowls, the 2" screw should be used (R.H. for inboard and L.H. for outboard turning). Having trouble differentiating right hand and left hand screws? See page 21.

### **CHUCK SPURS**

If you often switch from chuck work, to working between centers, consider a *ONEWAY* chuck spur. It mounts directly into your chuck, which eliminates having to remove and re-install your chuck from your spindle. Chuck Spurs are manufactured in two sizes; 1/2" and 1".

## SECTION 5 - *ONEWAY* TURNING TIPS

This section of this instruction manual is devoted to turning tips, and ways to maximize the use of your chuck.

---

### *BOWLS AND PLATTERS*

There are many ways to hold your work piece for turning it into a bowl or platter. Here are three good methods:

#### **METHOD ONE:** Screw Chucking

Mount the Jumbo Screw in your chuck. The base jaws should sit in the grooves or flats which have been milled along the length of the head, and the groove around the head of the screw will fit in the reduced top jaw section (see page 6 & 7). (NOTE: No. 1 Jaws cannot be used with the Jumbo screw). After the screw is seated properly in your chuck, drill an 11/32" (9 mm) hole about 3/4" (19 mm) deep in the part of the wood blank which will be the inside of the bowl when it's finished. Thread the blank onto the screw, making sure the face of the blank is in contact with the jaws. You may have to lock your spindle if you are having trouble holding the chuck stationary while threading the blank onto the screw. (Never forget to unlock your spindle before starting up your lathe, and it's a good idea to get into the habit of never leaving the levers or key in the chuck while you are doing something else). Once your blank is mounted on the screw, you can rough or finish turn the outside. To be able to mount your bowl for turning the second side, turn a foot, spigot or recess for holding. Now you can remove the blank

from the screw by rotating counter clockwise, (if you have trouble getting the blank off the screw, it helps if you loosen the jaws off of the screw just enough to break contact with the jaw faces). Next, turn the blank around and grip on the spigot or the recess. You may wish to wrap some tape around your spigot if damage from the chuck jaws is not acceptable. If you have turned a foot, and want to ensure zero damage, you could also use a glue block at this point (refer to Method 3). When holding by recess, damage will be negligible. You are now ready to hollow the bowl.

#### **METHOD TWO: Large Drill**

With a large drill or forstner bit, drill a hole to suitable diameter (2-3/8" MINIMUM) and depth (7/32" max or deeper) which acts as a recess. You can now grip on this recess by expansion chucking and turn the outside of the bowl. As in method one, turn a foot, a spigot, or a recess for holding. Loosen the chuck, remove the blank, turn it around and now grip the blank on the backside and hollow out the bowl. This method is faster for larger quantities of bowls, but the large hole requires a good drill press setup.

#### **METHOD THREE: Glue Block**

A third method involves a glue block. Drill an 11/32" (9mm) hole in what will be the inside of the bowl. Mount the jumbo screw in the chuck, and thread the blank on the screw. Finish turn the outside of the bowl, and glue a block to the bottom of the bowl. Turn the glue

block round so it is concentric and can be gripped in the chuck. Remove the blank from the Jumbo Screw, and the Jumbo Screw from the chuck. You can then grip the glue block with the Top Jaws, and hollow the inside of the bowl. Using a glue block is especially appropriate when you don't want a foot, or tenon and don't have a means to turn it off. This method is also less wasteful if you are working with exotic or expensive wood, or if your blank is just the right size and you can't afford to waste wood on an unwanted spigot that you have to turn off later. *ONEWAY* suggests using hot melt glue on dry wood (this glue will not work on wet wood). Glue blocks can usually be knocked off - if you have trouble getting the glue block off, use a heat gun to soften the glue and then knock the glue block off. If working with wet wood,

---

### Differentiating Left from Right Handed Screws

Do you ever have trouble telling your right hand screws from your left hand screws? The threads of right hand screws point up towards the right, while the threads of left hand screws point up towards the left.

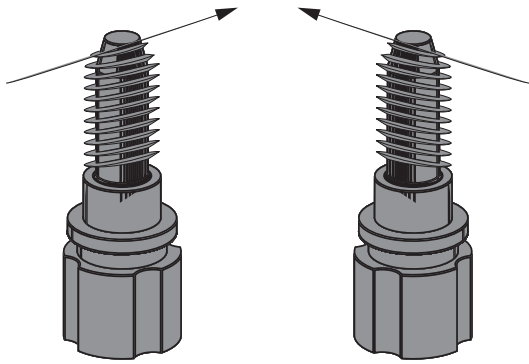

**RIGHT HAND**  
(inboard)

**LEFT HAND**  
(outboard)

TO MAKE TOPS or similar small components, simply mount a suitable piece of stock, square or preferably round. Due to the unique jaw shape, good holding will be achieved in either case. For tops, turn the point which will be in contact with the surface when spinning. You can then work towards the chuck, turning the spindle of the top, and part off.

### **MAXIMIZING YOUR GRIPPING POWER**

If turning a large piece of square stock, (especially if it is end grain) it is a good idea to initially chuck the "good" end. A spigot can be turned on the other end. The piece can then be turned around and gripped on the spigot. This is done for two reasons; firstly, the spigot can be turned small enough so that when it is chucked, the base jaws remain inside the diameter of the body, which reduces the risk of knuckles being injured if a catch occurs when working close to the chuck. Secondly, when holding in a spigot of the ideal diameter, you are also maximizing gripping power.

### **A FINISHING TIP**

If you are finishing a piece with a spray finish, such as lacquer, you may want to spray with the lathe off, and cover the chuck with some kind of protective shield. You can then remove the shield after spraying, turn the lathe on, and finish buffing with a rag or chips. Covering the chuck while spraying, will prevent it from becoming sticky and gumming up the scroll and jaws. This will ultimately keep your chuck running with smooth and easy action.

## The Lancaster Method for Turning Bowls using a Chuck

### **Step 1.**

Faceplate core out.

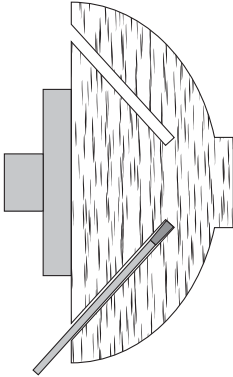

### **Step 2.**

Chuck on foot and rough turn the inside. Allow bowl to dry.

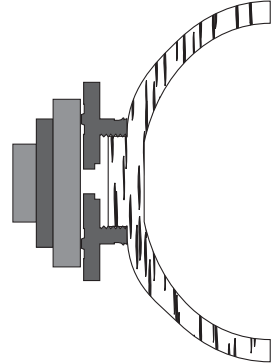

### **Step 3.**

Hold bowl between center and faceplate finish outside. True up the spigot.

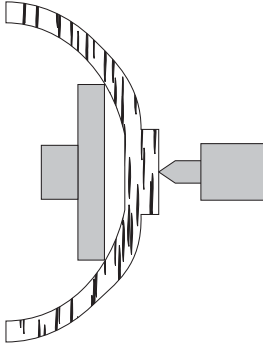

### **Step 4.**

Chuck on foot and finish turn inside (See illustration of step 2).

### **Step 5.**

Chuck with Jumbo Jaws and finish foot. Optionally use a vacuum system to finish the outside.

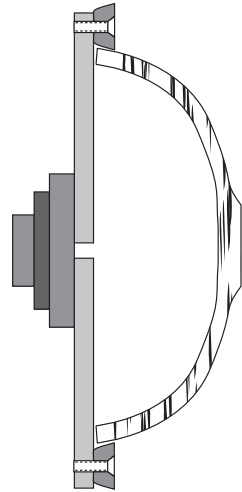

## SAFETY TIPS

As when working with any tools, a sensible approach and simple safety precautions should be followed.

1. Always wear proper clothing and face protection. Also use adequate exhaust and respiration equipment, especially when turning or sanding toxic or spalted woods, or when spraying with any liquid material.
2. Before loading the chuck, check that the wood is not split, cracked, or otherwise weakened. Do not load damaged wood in your chuck for turning.
3. The capacity of ONEWAY chucks depends on various factors such as whether the wood is wet or dry, soft or hard or whether turning end grain or side grain and whether the piece is balanced.
4. Be sure wood is gripped tightly in the chuck before rotating the chuck under power. Tighten the chuck with the levers or the key.
5. For safe use with hand chisels, do not extend the jaws beyond the chuck body.
6. Always rotate the chuck manually to be sure of clearances before starting your lathe. Don't forget to remove the levers or key from the Chuck before starting your lathe.



## SAFETY TIPS...continued

7. Never wrap any strip sand paper or clothing around your hands or fingers when sanding or turning. Do not wear gloves when turning.
8. Only light cutting can be performed when holding long square stock without centre support, especially where soft or wet woods are involved. For best results on longer parts and heavy cutting, use the tip on page 22 for MAXIMIZING YOUR GRIPPING POWER.
9. Using dull tools and poor technique will cause problems with any chucking system. By using properly sharpened tools and good technique, you will be guaranteed better results and safer turning.
10. When turning parts held between the chuck and live center, be sure the center is accurately aligned or oscillation will soon loosen the chuck's grip.
11. For end grain hollowing in goblets or bowls, a ring tool such as the TERMITE made by *ONEWAY* will, because of its gentle cutting nature, allow safer deeper hollowing than previously possible with gouges and large scrapers.

### **WARNING**

*Always check and re-tighten after a catch or when some time elapses between uses to take care of warp and/or shrinkage. With care you may turn fairly long lengths unsupported, but for safety, whenever possible, use a center for support and to prevent accidents.*



## **MANUFACTURERS WARRANTY**



Date Purchased: .....

If you are not happy with this product, for whatever reason, return it within 90 days of purchase, for a full refund or credit. You are responsible for shipping the product back to us and any costs incurred.

Manufactured parts on this ONEWAY product are backed by a warranty period of **two years** from the date of purchase.



ONEWAY hereby agrees to repair or replace, any defects due to faulty material or workmanship, provided that:

1. The warranty period has not elapsed. Proof of purchase date (sales receipt etc.) is required prior to any repair taking place.
2. The product has not been altered or modified in any way.
3. The product has not been subjected to misuse, abuse, negligence, or was not used strictly in accordance with these instructions.
4. Transportation costs incurred in returning the product to ONEWAY Manufacturing is **pre-paid by the customer**.

This warranty does not cover any costs or damages arising directly or indirectly from the operation of this product.

No other guarantee, written or verbal, is authorized by ONEWAY Manufacturing.

*Our policy is one of continuous improvement. We therefore reserve the right to change the specification and/or design without notice.*



---

If you require technical assistance, call us toll free at  
**1.800.565.7288**

---

ONEWAY WARRANTY CARD

Name: \_\_\_\_\_

Address: \_\_\_\_\_

City: \_\_\_\_\_

Province/State: \_\_\_\_\_ Postal Code/Zip: \_\_\_\_\_

Phone: \_\_\_\_\_

Date: \_\_\_\_\_

Place of Purchase: \_\_\_\_\_

Batch Number: \_\_\_\_\_

*(stamped on the side of the body)*

Would you like us to send you a *ONEWAY* catalogue? YES / NO

Comments: \_\_\_\_\_

\_\_\_\_\_



## ONEWAY & TALON ACCESSORIES

There are several Jaws Sets which can be quickly and easily inter-changed on these chucks.

---

### **Step Jaws**

*Part No: 2156*



### **Spigot Jaws**

*Part No. 3014 (ow) / 3016 (tn)*



---

### **\* #3 Jaws**

*Part No (ow/tn): 2158 / 3015*



---

### **Jumbo Jaws**

*Part No: 2047*



---

### **Dovetail Jaws**

*Part No. 2573*



---

### **Flat Jaws**

*Part No. 2678*



241 Monteith Ave, Stratford, ON, N5A 5X6, Canada

**1.800.565.7288**

[www.oneway.ca](http://www.oneway.ca)