



24770

## OWNER'S MANUAL AFS-1000B Air Filtration



**JET EQUIPMENT & TOOLS, INC.**  
A WMH Company  
[www.jettools.com](http://www.jettools.com)

P.O. BOX 1349  
Auburn, WA 98071-1349  
e-mail [jet@jettools.com](mailto:jet@jettools.com)

253-351-6000  
Fax 800-274-6840  
**M-708620 5/01**  
RTD10000188AA

This manual has been prepared for the owner and operators of a JET Air Filtration System. Its purpose, aside from machine operation, is to promote safety through the use of accepted correct operating and maintenance procedures. Completely read the safety and maintenance instructions before operating or servicing the machine. To obtain maximum life and efficiency from your Air Filtration System, and to aid in using the machine safely, read this manual thoroughly and follow instructions carefully.

### **Warranty & Service**

The JET Group warrants every product it sells. If one of our tools needs service or repair, one of our Authorized Repair Stations located throughout the United States can give you quick service.

In most cases, any one of these JET Group Repair Stations can authorize warranty repair, assist you in obtaining parts, or perform routine maintenance and major repair on your JET, Performax or Powermatic tools.

For the name of an Authorized Repair Station in your area, please call 1-800-274-6848.

### **More Information**

Remember, the JET Group is consistently adding new products to the line. For complete, up-to-date product information, check with your local JET Group distributor.

### **JET Group Warranty**

The JET Group (including Performax and Powermatic brands) makes every effort to assure that its products meet high quality and durability standards and warrants to the original retail consumer/purchaser of our products that each product be free from defects in materials and workmanship as follow: 1 YEAR LIMITED WARRANTY ON ALL PRODUCTS UNLESS SPECIFIED OTHERWISE. This Warranty does not apply to defects due directly or indirectly to misuse, abuse, negligence or accidents, normal wear-and-tear, repair or alterations outside our facilities, or to a lack of maintenance.

THE JET GROUP LIMITS ALL IMPLIED WARRANTIES TO THE PERIOD SPECIFIED ABOVE, FROM THE DATE THE PRODUCT WAS PURCHASED AT RETAIL. EXCEPT AS STATED HEREIN, ANY IMPLIED WARRANTIES OR MERCHANTABILITY AND FITNESS ARE EXCLUDED. SOME STATES DO NOT ALLOW LIMITATIONS ON HOW LONG THE IMPLIED WARRANTY LASTS, SO THE ABOVE LIMITATION MAY NOT APPLY TO YOU. THE JET GROUP SHALL IN NO EVENT BE LIABLE FOR DEATH, INJURIES TO PERSONS OR PROPERTY, OR FOR INCIDENTAL, CONTINGENT, SPECIAL, OR CONSEQUENTIAL DAMAGES ARISING FROM THE USE OF OUR PRODUCTS. SOME STATES DO NOT ALLOW THE EXCLUSION OR LIMITATION OF INCIDENTAL OR CONSEQUENTIAL DAMAGES, SO THE ABOVE LIMITATION OR EXCLUSION MAY NOT APPLY TO YOU.

To take advantage of this warranty, the product or part must be returned for examination, postage prepaid, to an Authorized Repair Station designated by our office. Proof of purchase date and an explanation of the complaint must accompany the merchandise. If our inspection discloses a defect, we will either repair or replace the product, or refund the purchase price if we cannot readily and quickly provide a repair or replacement, if you are willing to accept a refund. We will return repaired product or replacement at JET'S expense, but if it is determined there is no defect, or that the defect resulted from causes not within the scope of JET'S warranty, then the user must bear the cost of storing and returning the product. This warranty gives you specific legal rights; you may also have other rights which vary from state to state.

The JET Group sells through distributors only. Members of the JET Group reserve the right to effect at any time, without prior notice, those alterations to parts, fittings, and accessory equipment which they may deem necessary for any reason whatsoever.

## **WARNING**

1. **FOR YOUR OWN SAFETY, READ INSTRUCTION MANUAL BEFORE OPERATING THE TOOL.** Learn the tool's application and limitations as well as the specific hazards peculiar to it.
2. **KEEP GUARDS IN PLACE** and in working order.
3. **ALWAYS WEAR EYE PROTECTION.**
4. **GROUND ALL TOOLS.** If tool is equipped with three prong plug, it should be plugged into a three-hole electrical receptacle. If an adapter is used to accommodate a two prong receptacle, the adapter lug must be attached to a known ground. Never remove the third prong.
5. **KEEP WORK AREA CLEAN.** Cluttered areas and benches invite accidents.
6. **DON'T USE IN DANGEROUS ENVIRONMENT.** Don't use power tools in damp or wet locations, or expose them to rain. Keep work area well-lighted.
7. **KEEP CHILDREN AND VISITORS AWAY.** All children and visitors should be kept a safe distance from work area.
8. **MAKE WORKSHOP CHILDPROOF.** Use padlocks, master switches, or remove starter keys.
9. **DON'T FORCE TOOL.** It will do the job better and be safer at the rate for which it was designed.
10. **USE RIGHT TOOL.** Don't force tool or attachment to do a job for which it was not designed.
11. **WEAR PROPER APPAREL.** No loose clothing, gloves, neckties, rings, bracelets, or other jewelry to get caught in moving parts. Nonslip footwear is recommended. Wear protective hair covering to contain long hair.
12. **ALWAYS USE SAFETY GLASSES.** Wear safety glasses (must comply with ANSI Z87.1). Everyday eyeglasses only have impact resistant lenses; they are not safety glasses. Also use face or dust mask if cutting operation is dusty.
13. **SECURE WORK.** Use clamps or a vise to hold work when practical. It's safer than using your hands and frees both hands to operate tool.
14. **DON'T OVERREACH.** Keep proper footing and balance at all times.
15. **MAINTAIN TOOLS IN TOP CONDITION.** Keep tools sharp and clean for best and safest performance. Follow instructions for lubricating and changing accessories.
16. **DISCONNECT TOOLS** before servicing and when filters.
17. **USE RECOMMENDED ACCESSORIES.** The use of accessories and attachments not recommended by manufacturer may cause hazards or risk of injury to persons.
18. **AVOID ACCIDENTAL STARTING.** Make sure switch is in "OFF" position before plugging in power cord.
19. **NEVER STAND ON TOOL.** Serious injury could occur if the tool is tipped or if the fan blade is accidentally contacted.
20. **CHECK DAMAGED PARTS.** Before further use of the tool, a guard or other part that is damaged should be carefully checked to ensure that it will operate properly and perform its intended function-check for alignment of moving parts, binding of moving parts, breakage of parts, mounting, and any other conditions that may affect its operation. A guard or other part that is damaged should be properly repaired or replaced.
21. **NEVER LEAVE TOOL RUNNING UNATTENDED. TURN POWER OFF.** Don't leave tool until it comes to a complete stop.
22. **DRUGS, ALCOHOL, MEDICATION.** Do not operate tool while under the influence of drugs, alcohol or any medication.
23. **MAKE SURE TOOL IS DISCONNECTED FROM POWER SUPPLY** while motor is being mounted, connected or reconnected.
24. **WARNING:** Some dust created by power sanding, sawing, grinding, drilling and other construction activities contains chemicals known to cause cancer, birth defects or other reproductive harm. Some examples of these chemicals are:
  - Lead from lead based paint
  - crystalline silica from bricks and cement and other masonry products, and
  - arsenic and chromium from chemically-treated lumber.
25. Your risk from those exposures varies, depending on how often you do this type of work. To reduce your exposure to these chemicals: work in a well ventilated area, and work with approved safety equipment, such as those dust masks that are specifically designed to filter out microscopic particles

## Electrical Requirements

In the event of a malfunction or breakdown, grounding provides a path of least resistance for electric current to reduce the risk of electric shock. This tool is equipped with an electric cord having an equipment-grounding conductor and a grounding plug. The plug must be plugged into a matching outlet that is properly installed and grounded in accordance with all local codes and ordinances.

Do not modify the plug provided. If it will not fit the outlet, have the proper outlet installed by a qualified electrician.

Improper connection of the equipment-grounding conductor can result in a risk of electric shock. The conductor, with insulation having an outer surface that is green with or without yellow stripes, is the equipment-grounding conductor. If repair or replacement of the electric cord or plug is necessary, do not connect the equipment-grounding conductor to a live terminal.

Check with a qualified electrician or service personnel if the grounding instructions are not completely understood, or if in doubt as to whether the tool is properly grounded.

Use only three wire extension cords that have three-prong grounding plugs and three-pole receptacles that accept the tool's plug.\*

Repair or replace a damaged or worn cord immediately.

This tool is intended for use on a circuit that has an outlet that looks the one illustrated in Figure A below. The tool has a grounding plug that looks like the grounding plug as illustrated in Figure A below. A temporary adapter, which looks like the adapter as illustrated in Figures B below, may be used to connect this plug to a two-pole receptacle, as shown in Figure B if a properly grounded outlet is not available.\*\* The temporary adapter should only be used until a properly grounded outlet can be installed by a qualified electrician. The green colored rigid ear or tab, extending from the adapter, must be connected to a permanent ground such as a properly grounded outlet box.

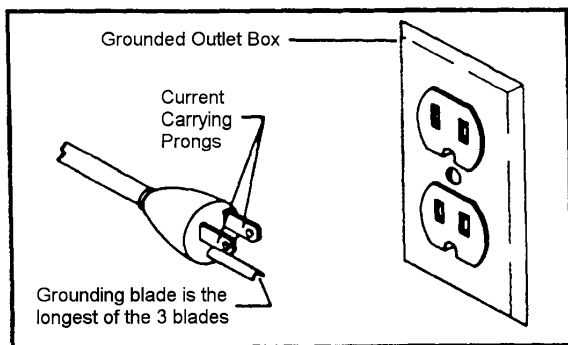

Fig. A

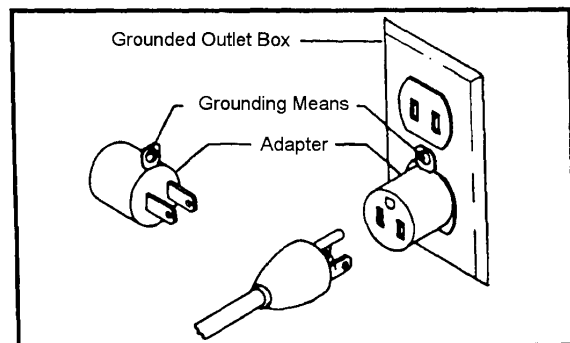

Fig. B

\* Canadian electrical codes require extension cords to be certified SJT type or better.

\*\* Use of an adapter in Canada is not acceptable.

## Specifications

**AFS-1000B**

Stock Number.....	708620
Outer Filter .....	5 Microns
Inner Filter .....	1 Micron
Overall Dimensions (LxWxH/in).....	30-1/4 x 24-1/8 x 12-1/8
Sound Rating @ 3ft .....	High Speed 69 dB
.....	Medium Speed 67 dB
.....	Low Speed 62 dB
Air Flow .....	High Speed 1044 CFM
.....	Medium Speed 702 CFM
.....	Low Speed 556 CFM
Motor.....	1/5 HP, 115V, 60Hz, 1 Ph, 6P
Net Weight.....	54 lbs.
Shipping Weight.....	61 lbs.

## Table of Contents

**Page**

Warranty.....	2
Warnings .....	3
Electrical Requirements .....	4
Specifications .....	5
Table of Contents .....	5
For Your Own Safety .....	5
Contents of Shipping Carton .....	6
Tools Required for Assembly .....	6
Assembly.....	6-7
Controls and Features .....	7-8
Changing Filters.....	8
Breakdown .....	9
Parts List .....	10

## FOR YOUR OWN SAFETY

1. Read and understand instruction manual before installing or operating air cleaner.
2. To reduce the risk of injury disconnect the air cleaner from the power source (unplug) before servicing or changing filters.
3. If ceiling mounted, bottom of air cleaner must be at least 7 feet above the floor.
4. If ceiling mounted, mounts must be anchored to building structure which will support a minimum of at least 100 pounds. Never mount to surfaces such as dry wall or false ceiling grids, etc.
5. To reduce the risk of electrical shock, do not expose air cleaner to water or rain.
6. Never duct a machine directly into the air cleaner.
7. To avoid a potentially dangerous situation, do not use this equipment to filter volatile fumes or smoke. This air cleaner is designed and intended for the filtration of air borne wood dust only. It is neither designed or intended for any other purpose whatsoever.
8. Failure to comply may result in serious injury and / or property damage.

The specifications in this manual are given as general information and are not binding. JET Equipment & Tools reserves the right to effect, at any time and without prior notice, changes or alterations to parts, fittings, and accessory equipment deemed necessary for any reason whatsoever.

## Contents of Shipping Carton

1. Air Filtration Unit
1. Remote Control
2. AAA Batteries
4. Eye Bolts & Nuts
4. Mounting Brackets
8. Hex Cap Screws
8. Lock Washers
4. Foam Pads
1. Velcro Pad
1. Manual and Warranty Card



## Tools Required for Assembly

- No. 2 Cross Point Screwdriver
  - 10mm Wrench
- 
- The air filtration unit does not require much assembly. You should take into consideration how and where you will place this unit.
  - It can be mounted horizontally and vertically. The unit can also be hung from the ceiling.
  - This unit will work best if it is located away from corners, and heating/cooling vents.
  - If using on sawhorses the air filtration unit should be clamped in place.
  - This unit is specifically designed to circulate and filter non-metallic dust, which is generated throughout the work area.

## Assembly

**CAUTION!**  
Mounts must be anchored to building structure, which will support a minimum of at least 100 pounds. Never mount to surfaces such as dry wall or false ceiling grids, etc.

1. Remove all packing from inside of the unit by removing the outer filter and inner filters.
2. The air filtration unit can be hung from the ceiling. Remove four screws from the cabinet top (A, Fig. 1).
3. Hang the unit using four eyebolts (B, Fig. 1), and four hex nuts (C, Fig. 1) provided.

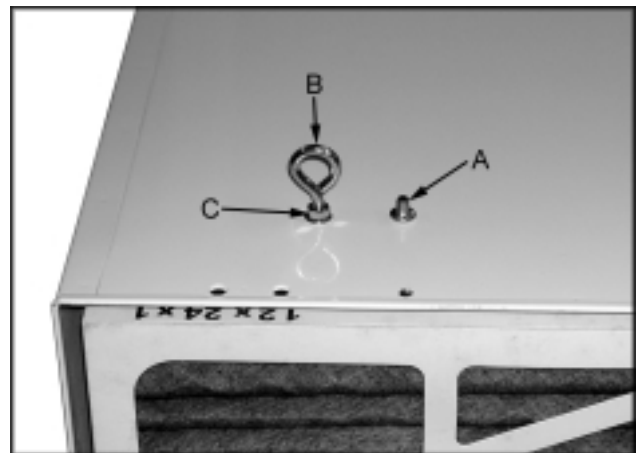

Fig. 1

4. The lock nut needs to be threaded almost all the way up the eyebolt. Screw the eye bolt into the hole and tighten lock nut against the cabinet top. You will need to hold the eyebolt so it does not spin while tightening the lock nut.
5. Repeat steps for remaining three eyebolts.

**Note:** Make sure chain and ceiling hooks are properly rated for hanging this unit. Hang unit with a seven-foot clearance from the floor.

**CAUTION!**

**Mounts must be anchored to building structure, which will support a minimum of at least 100 pounds. Never mount to surfaces such as dry wall or false ceiling grids, etc.**

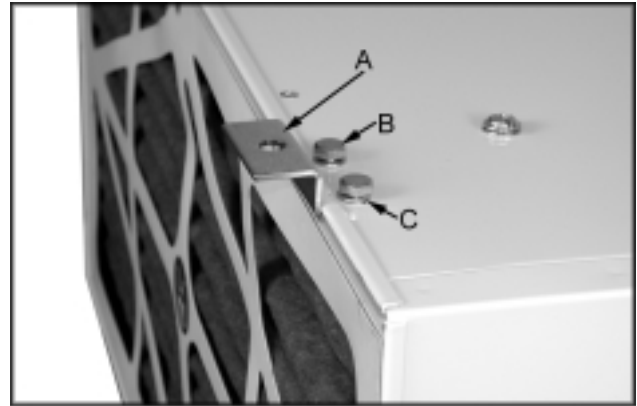

Fig. 2

1. Four brackets can also be used for mounting to the ceiling, or wall.
2. Place one end of bracket underneath the lip of the cabinet.
3. Attach the bracket (A, Fig. 2) with two hex cap screws (B, Fig. 2) and two lock washers (C, Fig. 2).
4. Repeat steps for remaining three brackets.
5. Peel off the paper backing, on the foam pads, and stick to the bottom side of the machine's four corners.

## Controls and Features

### Remote Control:

**Time** button (A, Fig. 3) controls the three different settings.

**2H** will light up on the back of the unit with one press of the time button. The air filtration system will operate for 2 hours then shut off.

**4H** will light up on the back of the unit by pressing the time button twice. The air filtration system will operate for 4 hours then shut off.

**8H** will light up on the back of the unit by pressing the time button three times. The air filtration system will operate for 8 hours then shut off.

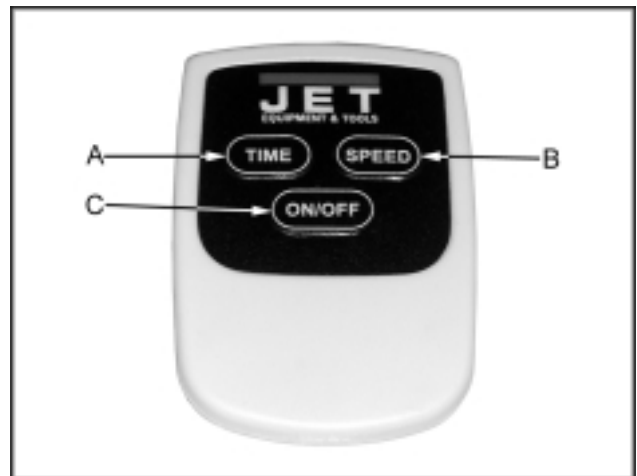

Fig. 3

**Speed** button (B, Fig. 3) controls the three different settings, Low, Medium and High. There is also a manual button (A, Fig. 4) on the backside of this unit which controls the speed.

**On/Off** button (C, Fig. 3) turns the unit on and off. There is also a manual on/off button (B, Fig. 4) on the backside of the unit. Pressing this button will turn the machine on Low.

**Fuse** switch (C, Fig. 4) will pop out in the case of overload. Wait 3-5 minutes and push the fuse in.



Fig. 4

## Changing the Filters

**⚠ WARNING**

**To reduce the risk of injury disconnect the air cleaner from the power source (unplug) before servicing or changing filters. Failure to comply may cause serious injury!**

There are two filters that need to be changed. The outer filter can easily be removed by disengaging the two clips (A, Fig. 5).

Now you can simply pull the filter out, or use a screwdriver to pop the filter out.

The inner filter (A, Fig. 6) can now be pulled out of the unit. The inner filter can be blown out with air, or washed out.

The filters should be replaced depending on the amount of usage and the environment of your shop. Clogged filters will reduce the amount of air circulation. There is an arrow indicating the air flow direction on the outer filter. Make sure the filter is inserted facing the proper direction.

## Replacement Filters

- 708733 inner filter
- 708731 electrostatic filter
- 708734 charcoal filter
- 708732 washable electrostatic filter

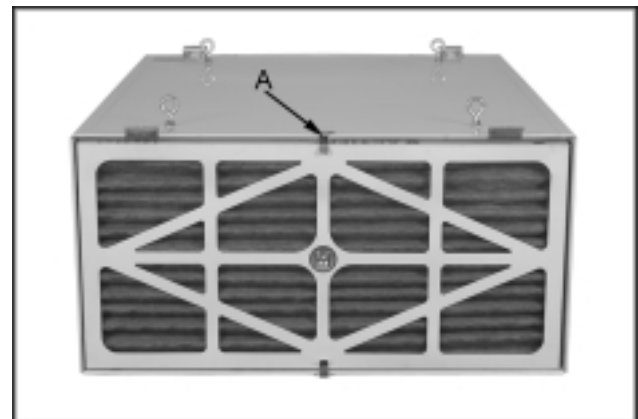

Fig. 5



Fig. 6



# Parts Breakdown

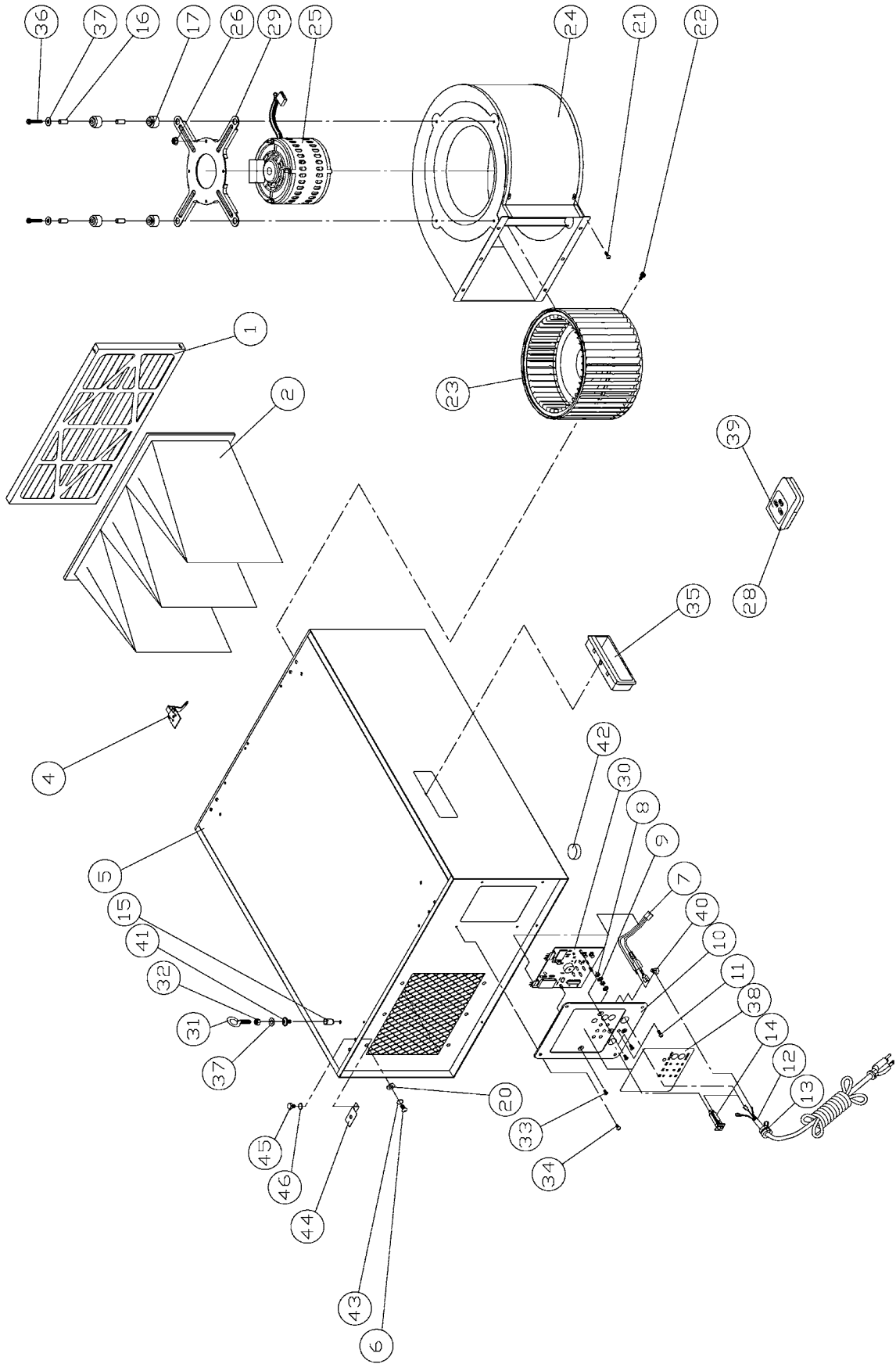

## Parts List for the AFS-1000B Air Filtration

Index No.	Part No.	Description	Size	Qty.
1.....	708731.....	Filter.....		1
2.....	708733.....	Filter Bag.....		1
4.....	AB001008.....	Door Clip Set.....		2
5.....	AB001108W.....	Air Box.....		1
6.....	SJ069300.....	Pan Head Bolt.....	M6x12.....	6
7.....	OO1033.....	Switch Wire w/Terminal.....		1
8.....	NH050800.....	Nut.....	M5.....	2
9.....	WE050000.....	Star Washer.....	M5.....	2
10.....	OO1022W.....	Switch Plate.....		1
.....	AB001022W.....	Switch Plate Set (assembly not shown).....		1
11.....	SP059300.....	Pan Head Bolt.....	M5x12.....	1
12.....	IC001015.....	Electric Wire.....		1
13.....	998623.....	Strain Relief.....		1
14.....	330075.....	5A Thermos Switch.....		1
15.....	10042.....	Nut.....	M6.....	4
16.....	330006.....	Sleeve.....		4
17.....	330005.....	Spacer.....		4
20.....	WF061310.....	Flat Washer.....	M6.....	6
21.....	ST049200.....	Tapping Screw.....	M4x8.....	2
22.....	SR089400.....	Hex Socket Bolt.....	M8x16.....	1
23.....	OO1055.....	Fan Blade.....		1
24.....	OO1056.....	Fan Housing.....		1
25.....	OO1057.....	Motor.....		1
.....	CA001000B.....	Capacitor (not shown).....		1
26.....	NF050800.....	Nut.....	M5.....	4
28.....	708711.....	Remote Control.....		1
29.....	330004.....	Flange.....		1
30.....	330043.....	PC Board.....		1
31.....	OO1023.....	Eye Bolt.....		4
32.....	NH061000.....	Nut.....	M6.....	4
33.....	SN490200.....	Counter Sunk Bolt.....	1/8"x1/4".....	3
34.....	SP049100.....	Pan Head Bolt.....	M4x6.....	4
35.....	OO1029.....	Concave Handle.....		2
36.....	SR060600.....	Hex Socket Bolt.....	M6x30.....	4
37.....	WF061620.....	Washer.....	M6x16.....	8
38.....	LM000513.....	I.D. Label.....		1
39.....	LM000344.....	Remote Label.....		1
40.....	990638.....	Wiring Nut.....	P2.....	1
41.....	SF069200.....	Rivet Nut.....	M6x8.....	4
42.....	330074.....	Pad.....		4
43.....	WS060000.....	Spring Washer.....	M6.....	6
44.....	OO1027.....	Hanger Plate.....		4
45.....	SH069200.....	Hex Head Bolt.....	M6x8.....	8
46.....	WS060000.....	Spring Washer.....	M6.....	8
.....	OO1045.....	Color Stripe (not shown).....		1
.....	AH001103.....	Hardware Kit (not shown).....		1
.....	LM000280.....	JET Air Filtration I.D. Label (not shown: side of cabinet).....		2
.....	LM000210.....	Warning Label.....		1

### Replacement Filters:

.....	708733.....	Inner Filter
.....	708731.....	Electrostatic Filter
.....	708734.....	Charcoal Filter
.....	708732.....	Washable Electrostatic Filter